

# G3PE-Single-phase

**Compact, Slim-profile SSRs with Heat Sinks. Models with No Zero Cross for a Wide Range of Applications.**



- RoHS compliant.
- Models also available with no zero cross
- Surge pass protection improved surge dielectric strength for output currents. (OMRON testing)
- Compact with a slim profile.
- Mount to DIN Track or with screws.
- Conforms to UL, CSA, and EN standards (TÜV certification).



 Refer to *Safety Precautions* at the end of this document.

## Ordering Information

### List of Models

| Number of phases | Insulation method  | Operation indicator | Rated input voltage | Zero cross function | Applicable load *    | Model                     |
|------------------|--------------------|---------------------|---------------------|---------------------|----------------------|---------------------------|
| Single-phase     | Phototriac coupler | Yes (yellow)        | 12 to 24 VDC        | Yes                 | 15 A, 100 to 240 VAC | <b>G3PE-215B DC12-24</b>  |
|                  |                    |                     |                     |                     | 25 A, 100 to 240 VAC | <b>G3PE-225B DC12-24</b>  |
|                  |                    |                     |                     |                     | 35 A, 100 to 240 VAC | <b>G3PE-235B DC12-24</b>  |
|                  |                    |                     |                     |                     | 45 A, 100 to 240 VAC | <b>G3PE-245B DC12-24</b>  |
|                  |                    |                     |                     | No                  | 15 A, 100 to 240 VAC | <b>G3PE-215BL DC12-24</b> |
|                  |                    |                     |                     |                     | 25 A, 100 to 240 VAC | <b>G3PE-225BL DC12-24</b> |
|                  |                    |                     |                     |                     | 35 A, 100 to 240 VAC | <b>G3PE-235BL DC12-24</b> |
|                  |                    |                     |                     |                     | 45 A, 100 to 240 VAC | <b>G3PE-245BL DC12-24</b> |
|                  |                    |                     |                     | Yes                 | 15 A, 200 to 480 VAC | <b>G3PE-515B DC12-24</b>  |
|                  |                    |                     |                     |                     | 25 A, 200 to 480 VAC | <b>G3PE-525B DC12-24</b>  |
|                  |                    |                     |                     |                     | 35 A, 200 to 480 VAC | <b>G3PE-535B DC12-24</b>  |
|                  |                    |                     |                     |                     | 45 A, 200 to 480 VAC | <b>G3PE-545B DC12-24</b>  |
|                  |                    |                     |                     | No                  | 15 A, 200 to 480 VAC | <b>G3PE-515BL DC12-24</b> |
|                  |                    |                     |                     |                     | 25 A, 200 to 480 VAC | <b>G3PE-525BL DC12-24</b> |
|                  |                    |                     |                     |                     | 35 A, 200 to 480 VAC | <b>G3PE-535BL DC12-24</b> |
|                  |                    |                     |                     |                     | 45 A, 200 to 480 VAC | <b>G3PE-545BL DC12-24</b> |

\* The applicable load current depends on the ambient temperature. For details, refer to *Load Current vs. Ambient Temperature* in *Engineering Data*.

# G3PE-Single-phase

## Specifications

### Certification

UL508, CSA22.2 No.14, and EN60947-4-3

### Ratings

#### Input (at an Ambient Temperature of 25°C)

| Model      | Item         | Rated voltage | Operating voltage range | Rated input current | Voltage level        |                      |
|------------|--------------|---------------|-------------------------|---------------------|----------------------|----------------------|
|            |              |               |                         |                     | Must operate voltage | Must release voltage |
| G3PE-□□□B  | 12 to 24 VDC | 9.6 to 30 VDC | 7 mA max.               | 9.6 VDC max.        | 1.0 VDC max.         |                      |
| G3PE-□□□BL |              |               | 15 mA max.              |                     |                      |                      |

#### Output

| Item   | Model | G3PE-215B(L)              | G3PE-225B(L)           | G3PE-235B(L)           | G3PE-245B(L)          | G3PE-515B(L)              | G3PE-525B(L)           | G3PE-535B(L)           | G3PE-545B(L)          |
|--|-------|---------------------------|------------------------|------------------------|-----------------------|---------------------------|------------------------|------------------------|-----------------------|
| Rated load voltage                             |       | 100 to 240 VAC (50/60 Hz) |                        |                        |                       | 200 to 480 VAC (50/60 Hz) |                        |                        |                       |
| Load voltage range                             |       | 75 to 264 VAC (50/60 Hz)  |                        |                        |                       | 180 to 528 VAC (50/60 Hz) |                        |                        |                       |
| Applicable load current *                      |       | 0.1 to 15 A (at 40°C)     | 0.1 to 25 A (at 40°C)  | 0.5 to 35 A (at 25°C)  | 0.5 to 45 A (at 25°C) | 0.1 to 15 A (at 40°C)     | 0.1 to 25 A (at 40°C)  | 0.5 to 35 A (at 25°C)  | 0.5 to 45 A (at 25°C) |
| Inrush current resistance                      |       | 150 A (60 Hz, 1 cycle)    | 220 A (60 Hz, 1 cycle) | 440 A (60 Hz, 1 cycle) |                       | 150 A (60 Hz, 1 cycle)    | 220 A (60 Hz, 1 cycle) | 440 A (60 Hz, 1 cycle) |                       |
| Permissible I <sup>2</sup> t (reference value) |       | 121A <sup>2</sup> s       | 260A <sup>2</sup> s    | 1,260A <sup>2</sup> s  |                       | 128A <sup>2</sup> s       | 1,350A <sup>2</sup> s  |                        | 6,600A <sup>2</sup> s |
| Applicable load (resistive load)               |       | 3 kW (at 200 VAC)         | 5 kW (at 200 VAC)      | 7 kW (at 200 VAC)      | 9 kW (at 200 VAC)     | 6 kW (at 400 VAC)         | 10 kW (at 400 VAC)     | 14 kW (at 400 VAC)     | 18 kW (at 400 VAC)    |

\* The applicable load current depends on the ambient temperature. For details, refer to *Load Current vs. Ambient Temperature* in *Engineering Data* on page 1228.

### Characteristics

| Item                          | Model | G3PE-215B  | G3PE-225B | G3PE-235B     | G3PE-245B | G3PE-215BL    | G3PE-225BL | G3PE-235BL    | G3PE-245BL |
|-------------------------------|-------|--|-----------|---------------|-----------|---------------|------------|---------------|------------|
| Operate time                  |       | 1/2 of load power source cycle + 1 ms max.   |           |               |           | 1 ms max.     |            |               |            |
| Release time                  |       | 1/2 of load power source cycle + 1 ms max.   |           |               |           |               |            |               |            |
| Output ON voltage drop        |       | 1.6 V (RMS) max.   |           |               |           |               |            |               |            |
| Leakage current               |       | 10 mA max. (at 200 VAC)  |           |               |           |               |            |               |            |
| Insulation resistance         |       | 100 MΩ min. (at 500 VDC)   |           |               |           |               |            |               |            |
| Dielectric strength           |       | 2,500 VAC, 50/60 Hz for 1 min  |           |               |           |               |            |               |            |
| Vibration resistance          |       | 10 to 55 to 10 Hz, 0.375-mm single amplitude (0.75-mm double amplitude) (Mounted to DIN track) |           |               |           |               |            |               |            |
| Shock resistance              |       | Destruction: 294 m/s <sup>2</sup> (Mounted to DIN track)                                       |           |               |           |               |            |               |            |
| Ambient storage temperature   |       | -30 to 100°C (with no icing or condensation)   |           |               |           |               |            |               |            |
| Ambient operating temperature |       | -30 to 80°C (with no icing or condensation)  |           |               |           |               |            |               |            |
| Ambient operating humidity    |       | 45% to 85%   |           |               |           |               |            |               |            |
| Weight                        |       | Approx. 240 g  |           | Approx. 400 g |           | Approx. 240 g |            | Approx. 400 g |            |

| Model Item                    | G3PE-515B  | G3PE-525B | G3PE-535B     | G3PE-545B | G3PE-515BL    | G3PE-525BL | G3PE-535BL    | G3PE-545BL |
|-------------------------------|--|-----------|---------------|-----------|---------------|------------|---------------|------------|
| Operate time                  | 1/2 of load power source cycle + 1 ms max.   |           |               |           | 1 ms max.     |            |               |            |
| Release time                  | 1/2 of load power source cycle + 1 ms max.   |           |               |           |               |            |               |            |
| Output ON voltage drop        | 1.8 V (RMS) max.   |           |               |           |               |            |               |            |
| Leakage current               | 20 mA max. (at 480 VAC)  |           |               |           |               |            |               |            |
| Insulation resistance         | 100 MΩ min. (at 500 VDC)   |           |               |           |               |            |               |            |
| Dielectric strength           | 2,500 VAC, 50/60 Hz for 1 min  |           |               |           |               |            |               |            |
| Vibration resistance          | 10 to 55 to 10 Hz, 0.375-mm single amplitude (0.75-mm double amplitude) (Mounted to DIN track) |           |               |           |               |            |               |            |
| Shock resistance              | Destruction: 294 m/s <sup>2</sup> (Mounted to DIN track)                                       |           |               |           |               |            |               |            |
| Ambient storage temperature   | -30 to 100°C (with no icing or condensation)   |           |               |           |               |            |               |            |
| Ambient operating temperature | -30 to 80°C (with no icing or condensation)  |           |               |           |               |            |               |            |
| Ambient operating humidity    | 45% to 85%   |           |               |           |               |            |               |            |
| Weight                        | Approx. 240 g  |           | Approx. 400 g |           | Approx. 240 g |            | Approx. 400 g |            |

Engineering Data

Input Voltage vs. Input Impedance and Input Voltage vs. Input Current

G3PE-2□□B

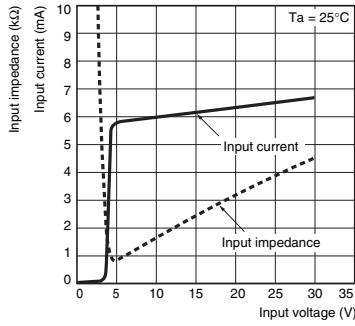

G3PE-2□□BL

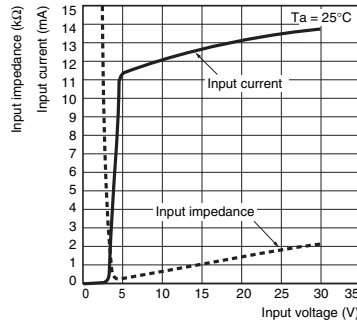

G3PE-5□□B

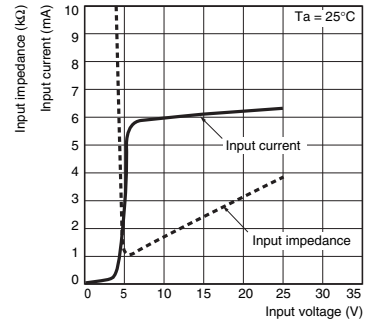

G3PE-5□□BL

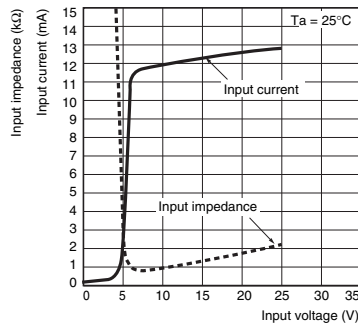

Load Current vs. Ambient Temperature

G3PE-215B(L), G3PE-225B(L)  
G3PE-515B(L), G3PE-525B(L)

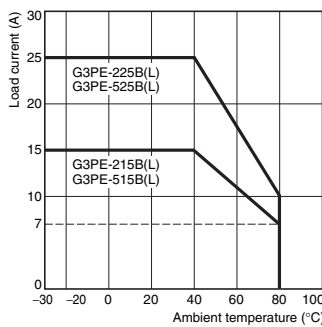

G3PE-235B(L), G3PE-245B(L)  
G3PE-535B(L), G3PE-545B(L)

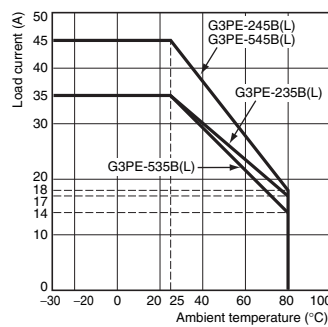

Inrush Current Resistance: Non-repetitive

Keep the inrush current to below the inrush current resistance value (i.e., below the broken line) if it occurs repetitively.

G3PE-215B(L), G3PE-515B(L)

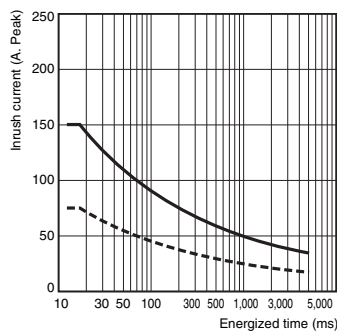

G3PE-225B(L), G3PE-525B(L)

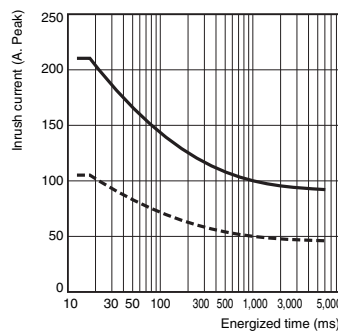

G3PE-235B(L), G3PE-245B(L)  
G3PE-535B(L), G3PE-545B(L)

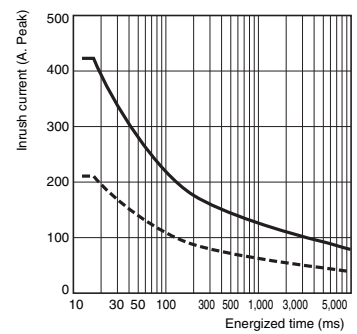

# G3PE-Single-phase

## Close Mounting (3 or 8 SSRs)

**G3PE-215B(L)**

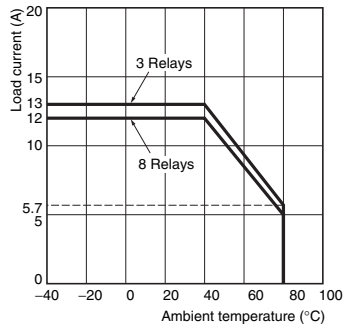

**G3PE-225B(L)**

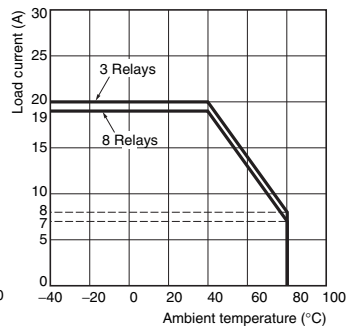

**G3PE-235B(L)**

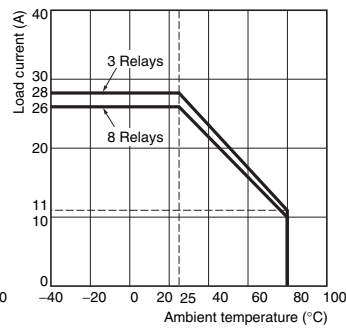

**G3PE-245B(L)**

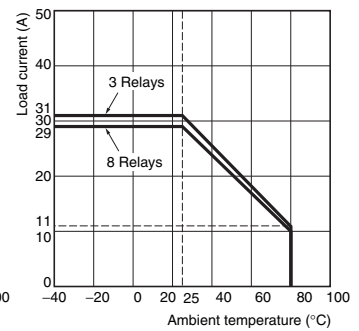

**G3PE-515B(L)**

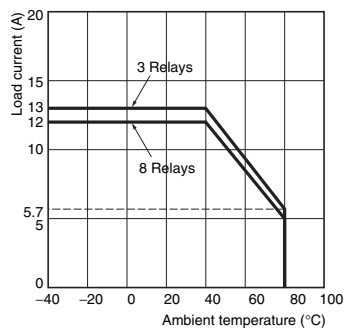

**G3PE-525B(L)**

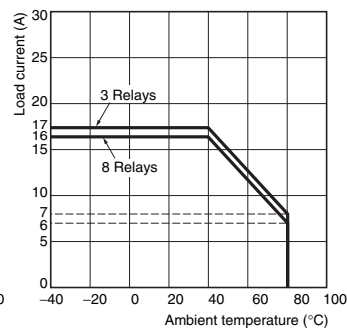

**G3PE-535B(L)**

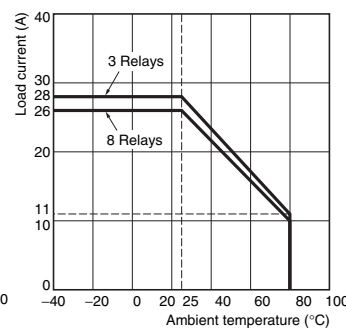

**G3PE-545B(L)**

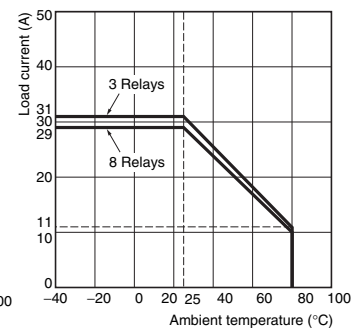

## Close Mounting Example

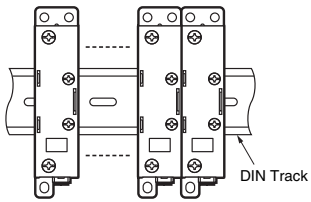

# Dimensions

Note: All units are in millimeters unless otherwise indicated.

## Solid State Relays

- G3PE-215B(L)
- G3PE-225B(L)
- G3PE-515B(L)
- G3PE-525B(L)

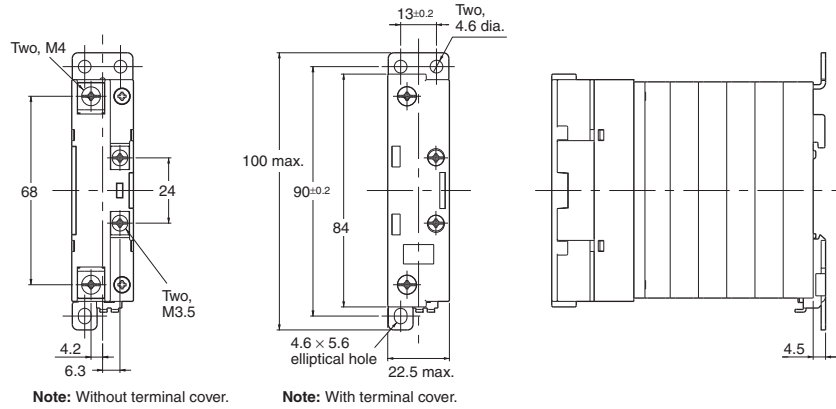

Note: Without terminal cover.

Note: With terminal cover.

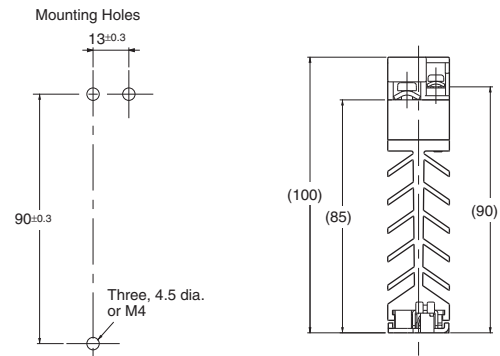

### Terminal Arrangement/Internal Circuit Diagram

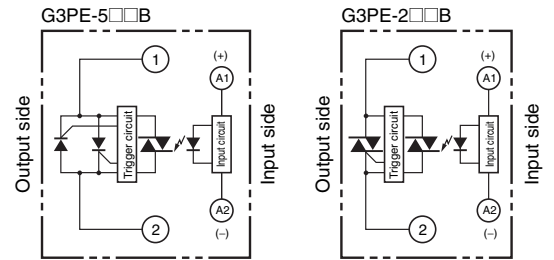

- G3PE-235B(L)
- G3PE-245B(L)
- G3PE-535B(L)
- G3PE-545B(L)

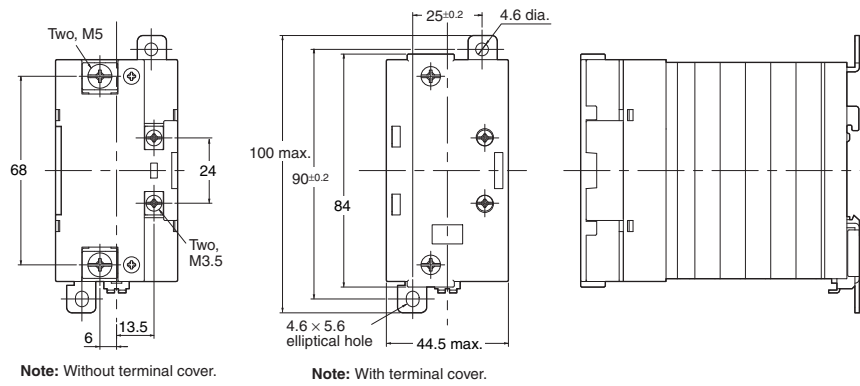

Note: Without terminal cover.

Note: With terminal cover.

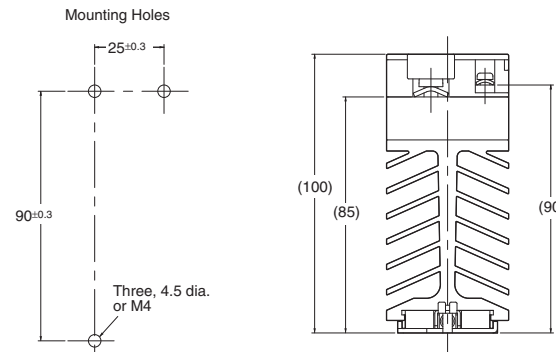

### Terminal Arrangement/Internal Circuit Diagram

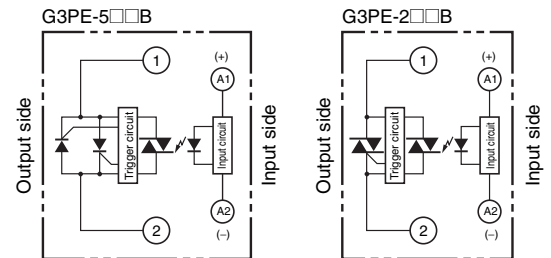

# G3PE-Three-phase

**Compact, Slim-profile SSRs with Heat Sinks.  
Solid State Contactors for Three-phase  
Heaters Reduced Installation Work  
with DIN Track Mounting.**

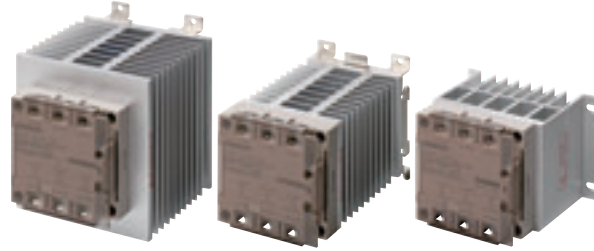

- RoHS compliant.
- Surge pass protection improved surge dielectric strength for output currents. (OMRON testing)
- Slim design with 3-phase output and built-in heat sinks.
- DIN Track mounting types and screw mounting types are available.  
All DIN Track mounting types mount to DIN Track (applicable DIN Track: TR35-15Fe (IEC 60715)).
- Conforms to UL, CSA, and EN standards (TÜV certification).

Refer to *Safety Precautions* at the end of this document.

## Ordering Information

### List of Models

#### Models with Built-in Heat Sinks

| Number of phases     | Insulation method  | Operation indicator    | Rated input voltage | Zero cross function | Type                  | Applicable load *1   | Number of poles      | Model                  |
|----------------------|--------------------|------------------------|---------------------|---------------------|-----------------------|----------------------|----------------------|------------------------|
| Three-phase          | Phototriac coupler | Yes (yellow)           | 12 to 24 VDC        | Yes                 | DIN track mounting *2 | 15 A, 100 to 240 VAC | 3                    | G3PE-215B-3N DC12-24   |
|                      |                    |                        |                     |                     |                       |                      | 2                    | G3PE-215B-2N DC12-24   |
|                      |                    |                        |                     |                     |                       | 25 A, 100 to 240 VAC | 3                    | G3PE-225B-3N DC12-24   |
|                      |                    |                        |                     |                     |                       |                      | 2                    | G3PE-225B-2N DC12-24   |
|                      |                    |                        |                     |                     |                       | 35 A, 100 to 240 VAC | 3                    | G3PE-235B-3N DC12-24   |
|                      |                    |                        |                     |                     |                       |                      | 2                    | G3PE-235B-2N DC12-24   |
|                      |                    |                        |                     |                     |                       | 45 A, 100 to 240 VAC | 3                    | G3PE-245B-3N DC12-24   |
|                      |                    |                        |                     |                     |                       |                      | 2                    | G3PE-245B-2N DC12-24   |
|                      |                    |                        |                     |                     |                       | 15 A, 200 to 480 VAC | 3                    | G3PE-515B-3N DC12-24   |
|                      |                    |                        |                     |                     |                       |                      | 2                    | G3PE-515B-2N DC12-24   |
|                      |                    |                        |                     |                     |                       | 25 A, 200 to 480 VAC | 3                    | G3PE-525B-3N DC12-24   |
|                      |                    |                        |                     |                     |                       |                      | 2                    | G3PE-525B-2N DC12-24   |
|                      |                    |                        |                     |                     | 35 A, 200 to 480 VAC  | 3                    | G3PE-535B-3N DC12-24 |                        |
|                      |                    |                        |                     |                     |                       | 2                    | G3PE-535B-2N DC12-24 |                        |
|                      |                    |                        |                     |                     | 45 A, 200 to 480 VAC  | 3                    | G3PE-545B-3N DC12-24 |                        |
|                      |                    |                        |                     |                     |                       | 2                    | G3PE-545B-2N DC12-24 |                        |
|                      |                    |                        |                     |                     | Screw mounting        | 15 A, 100 to 240 VAC | 3                    | G3PE-215B-3 DC12-24    |
|                      |                    |                        |                     |                     |                       |                      | 2                    | G3PE-215B-2 DC12-24 *3 |
|                      |                    |                        |                     |                     |                       | 25 A, 100 to 240 VAC | 3                    | G3PE-225B-3 DC12-24    |
|                      |                    |                        |                     |                     |                       |                      | 2                    | G3PE-225B-2 DC12-24    |
|                      |                    |                        |                     |                     |                       | 35 A, 100 to 240 VAC | 3                    | G3PE-235B-3 DC12-24    |
|                      |                    |                        |                     |                     |                       |                      | 2                    | G3PE-235B-2 DC12-24    |
|                      |                    |                        |                     |                     |                       | 45 A, 100 to 240 VAC | 3                    | G3PE-245B-3 DC12-24    |
|                      |                    |                        |                     |                     |                       |                      | 2                    | G3PE-245B-2 DC12-24    |
| 15 A, 200 to 480 VAC | 3                  | G3PE-515B-3 DC12-24    |                     |                     |                       |                      |                      |                        |
|                      | 2                  | G3PE-515B-2 DC12-24 *3 |                     |                     |                       |                      |                      |                        |
| 25 A, 200 to 480 VAC | 3                  | G3PE-525B-3 DC12-24    |                     |                     |                       |                      |                      |                        |
|                      | 2                  | G3PE-525B-2 DC12-24    |                     |                     |                       |                      |                      |                        |
| 35 A, 200 to 480 VAC | 3                  | G3PE-535B-3 DC12-24    |                     |                     |                       |                      |                      |                        |
|                      | 2                  | G3PE-535B-2 DC12-24    |                     |                     |                       |                      |                      |                        |
| 45 A, 200 to 480 VAC | 3                  | G3PE-545B-3 DC12-24    |                     |                     |                       |                      |                      |                        |
|                      | 2                  | G3PE-545B-2 DC12-24    |                     |                     |                       |                      |                      |                        |

\*1. The applicable load current depends on the ambient temperature. For details, refer to *Load Current vs. Ambient Temperature in Engineering Data* on page 1235.

\*2. The applicable DIN Track is the TR35-15Fe (IEC 60715). For details, refer to the mounting information in the *Safety Precautions for All G3PE Models* on page 1243.

\*3. DIN Track or Screw mounting.

## Models with Externally Attached Heat Sinks

| Number of phases     | Insulation method  | Operation indicator  | Rated input voltage | Zero cross function | Type                           | Applicable load *    | Number of poles | Model                |
|----------------------|--------------------|----------------------|---------------------|---------------------|--------------------------------|----------------------|-----------------|----------------------|
| Three-phase          | Phototriac coupler | Yes (yellow)         | 12 to 24 VDC        | Yes                 | Externally attached heat sinks | 15 A, 100 to 240 VAC | 3               | G3PE-215B-3H DC12-24 |
|                      |                    |                      |                     |                     |                                |                      | 2               | G3PE-215B-2H DC12-24 |
|                      |                    |                      |                     |                     |                                | 25 A, 100 to 240 VAC | 3               | G3PE-225B-3H DC12-24 |
|                      |                    |                      |                     |                     |                                |                      | 2               | G3PE-225B-2H DC12-24 |
|                      |                    |                      |                     |                     |                                | 35 A, 100 to 240 VAC | 3               | G3PE-235B-3H DC12-24 |
|                      |                    |                      |                     |                     |                                |                      | 2               | G3PE-235B-2H DC12-24 |
|                      |                    |                      |                     |                     |                                | 45 A, 100 to 240 VAC | 3               | G3PE-245B-3H DC12-24 |
|                      |                    |                      |                     |                     |                                |                      | 2               | G3PE-245B-2H DC12-24 |
|                      |                    |                      |                     |                     |                                | 15 A, 200 to 480 VAC | 3               | G3PE-515B-3H DC12-24 |
|                      |                    |                      |                     |                     |                                |                      | 2               | G3PE-515B-2H DC12-24 |
|                      |                    |                      |                     |                     |                                | 25 A, 200 to 480 VAC | 3               | G3PE-525B-3H DC12-24 |
|                      |                    |                      |                     |                     |                                |                      | 2               | G3PE-525B-2H DC12-24 |
|                      |                    |                      |                     |                     |                                | 35 A, 200 to 480 VAC | 3               | G3PE-535B-3H DC12-24 |
|                      |                    |                      |                     |                     |                                |                      | 2               | G3PE-535B-2H DC12-24 |
| 45 A, 200 to 480 VAC | 3                  | G3PE-545B-3H DC12-24 |                     |                     |                                |                      |                 |                      |
|                      | 2                  | G3PE-545B-2H DC12-24 |                     |                     |                                |                      |                 |                      |

\* The rated load current depends on the heat sink or radiator that is mounted. It also depends on the ambient temperature. For details, refer to *Load Current vs. Ambient Temperature* on page 1235.

## Accessories (Order Separately)

### Heat Sink

| Heat resistance Rth (s-a) (°C/W) | Model     |
|----------------------------------|-----------|
| 1.67                             | Y92B-P50  |
| 1.01                             | Y92B-P100 |
| 0.63                             | Y92B-P150 |
| 0.43                             | Y92B-P200 |
| 0.36                             | Y92B-P250 |

# G3PE-Three-phase

## Specifications

### Certification

UL508, CSA22.2 No.14, and EN60947-4-3

### Ratings (at an Ambient Temperature of 25°C)

#### Operating Circuit (All Models)

| Item/Model                      | Same for all models |
|---------------------------------|---------------------|
| Rated operating voltage         | 12 to 24 VDC        |
| Operating voltage range         | 9.6 to 30 VDC       |
| Rated input current (impedance) | 10 mA max. (24 VDC) |
| Must-operate voltage            | 9.6 VDC max.        |
| Must-release voltage            | 1 VDC min.          |
| Insulation method               | Phototriac          |
| Operation indicator             | Yellow LED          |

#### Main Circuit of Models with Built-in Heat Sinks

| Item   | Model | G3PE-215B-3(N)            | G3PE-215B-2(N)            | G3PE-225B-3(N)            | G3PE-225B-2(N)          | G3PE-235B-3(N)          | G3PE-235B-2(N)          | G3PE-245B-3(N)            | G3PE-245B-2(N)          | G3PE-515B-3(N) | G3PE-515B-2(N) | G3PE-525B-3(N)            | G3PE-525B-2(N) | G3PE-535B-3(N) | G3PE-535B-2(N) | G3PE-545B-3(N) | G3PE-545B-2(N) |
|--|-------|---------------------------|---------------------------|---------------------------|-------------------------|-------------------------|-------------------------|---------------------------|-------------------------|----------------|----------------|---------------------------|----------------|----------------|----------------|----------------|----------------|
| Rated load voltage                             |       | 100 to 240 VAC            |                           |                           |                         |                         |                         |                           |                         | 200 to 480 VAC |                |                           |                |                |                |                |                |
| Operating voltage range                        |       | 75 to 264 VAC             |                           |                           |                         |                         |                         |                           |                         | 180 to 528 VAC |                |                           |                |                |                |                |                |
| Rated load current *1                          |       | 15 A (at 40°C)            | 25 A (at 40°C)            | 35 A (at 25°C)            | 45 A (at 25°C)          | 15 A (at 40°C)          | 25 A (at 40°C)          | 35 A (at 25°C)            | 45 A (at 25°C)          |                |                |                           |                |                |                |                |                |
| Minimum load current                           |       | 0.2 A                     |                           |                           |                         |                         |                         |                           |                         | 0.5 A          |                |                           |                |                |                |                |                |
| Inrush current resistance (peak value)         |       | 150 A<br>(60 Hz, 1 cycle) | 220 A<br>(60 Hz, 1 cycle) | 440 A<br>(60 Hz, 1 cycle) |                         |                         |                         | 220 A<br>(60 Hz, 1 cycle) |                         |                |                | 440 A<br>(60 Hz, 1 cycle) |                |                |                |                |                |
| Permissible I <sup>2</sup> t (reference value) |       | 121A <sup>2</sup> s       | 260A <sup>2</sup> s       | 1,260A <sup>2</sup> s     |                         |                         |                         | 260A <sup>2</sup> s       |                         |                |                | 1,260A <sup>2</sup> s     |                |                |                |                |                |
| Applicable load (resistive load: AC1 class) *2 |       | 5.1 kW<br>(at 200 VAC)    | 8.6 kW<br>(at 200 VAC)    | 12.1 kW<br>(at 200 VAC)   | 15.5 kW<br>(at 200 VAC) | 12.5 kW<br>(at 480 VAC) | 20.7 kW<br>(at 480 VAC) | 29.0 kW<br>(at 480 VAC)   | 37.4 kW<br>(at 480 VAC) |                |                |                           |                |                |                |                |                |

\*1. The applicable load current depends on the ambient temperature. For details, refer to *Load Current vs. Ambient Temperature* in *Engineering Data* on page 1235.

\*2. Applicable Load

Use the following formula to calculate the maximum total capacity of a heater load for a three-phase balanced load with delta connections.

Maximum load capacity = Load current × Load voltage × √3

Example: 15 A × 200 V × √3 = 5,196 W ≅ 5.1 kW

Example: 15 A × 400 V × √3 = 10,392 W ≅ 10.3 kW

#### Main Circuit of Models with Externally Attached Heat Sinks

| Item   | Model | G3PE-215B-3H                                   | G3PE-215B-2H              | G3PE-225B-3HH             | G3PE-225B-2H   | G3PE-235B-3H   | G3PE-235B-2H   | G3PE-245B-3H              | G3PE-245B-2H   | G3PE-515B-3H   | G3PE-515B-2H | G3PE-525B-3H              | G3PE-525B-2H | G3PE-535B-3H | G3PE-535B-2H | G3PE-545B-3H | G3PE-545B-2H |
|--|-------|--|---------------------------|---------------------------|----------------|----------------|----------------|---------------------------|----------------|----------------|--------------|---------------------------|--------------|--------------|--------------|--------------|--------------|
| Rated load voltage                             |       | 100 to 240 VAC                                 |                           |                           |                |                |                |                           |                | 200 to 480 VAC |              |                           |              |              |              |              |              |
| Operating voltage range                        |       | 75 to 264 VAC                                  |                           |                           |                |                |                |                           |                | 180 to 528 VAC |              |                           |              |              |              |              |              |
| Rated load current *                           |       | 15 A (at 40°C)                                 | 25 A (at 40°C)            | 35 A (at 25°C)            | 45 A (at 25°C) | 15 A (at 40°C) | 25 A (at 40°C) | 35 A (at 25°C)            | 45 A (at 25°C) |                |              |                           |              |              |              |              |              |
| Minimum load current                           |       | 0.2 A  |                           |                           |                |                |                |                           |                | 0.5 A          |              |                           |              |              |              |              |              |
| Inrush current resistance (peak value)         |       | 150 A<br>(60 Hz, 1 cycle)                      | 220 A<br>(60 Hz, 1 cycle) | 440 A<br>(60 Hz, 1 cycle) |                |                |                | 220 A<br>(60 Hz, 1 cycle) |                |                |              | 440 A<br>(60 Hz, 1 cycle) |              |              |              |              |              |
| Permissible I <sup>2</sup> t (reference value) |       | 121A <sup>2</sup> s                            | 260A <sup>2</sup> s       | 1,260A <sup>2</sup> s     |                |                |                | 260A <sup>2</sup> s       |                |                |              | 1,260A <sup>2</sup> s     |              |              |              |              |              |
| Applicable load (resistive load: AC1 class)    |       | Refer to <i>Engineering Data</i> on page 1235. |                           |                           |                |                |                |                           |                |                |              |                           |              |              |              |              |              |

\* The rated load current depends on the heat sink or radiator that is mounted. It also depends on the ambient temperature. For details, refer to *Load Current vs. Ambient Temperature* in *Engineering Data* on page 1235.



## Characteristics

### Models with Built-in Heat Sinks

| Model                         | G3PE-215B-3(N)   | G3PE-215B-2(N)  | G3PE-225B-3(N)  | G3PE-225B-2(N)  | G3PE-235B-3(N)  | G3PE-235B-2(N) | G3PE-245B-3(N)  | G3PE-245B-2(N)  | G3PE-515B-3(N)          | G3PE-515B-2(N)  | G3PE-525B-3(N)  | G3PE-525B-2(N)  | G3PE-535B-3(N) | G3PE-535B-2(N)  | G3PE-545B-3(N) | G3PE-545B-2(N)  |
|-------------------------------|--|-----------------|-----------------|-----------------|-----------------|----------------|-----------------|-----------------|-------------------------|-----------------|-----------------|-----------------|----------------|-----------------|----------------|-----------------|
| Operate time                  | 1/2 of load power source cycle + 1 ms max.   |                 |                 |                 |                 |                |                 |                 |                         |                 |                 |                 |                |                 |                |                 |
| Release time                  | 1/2 of load power source cycle + 1 ms max.   |                 |                 |                 |                 |                |                 |                 |                         |                 |                 |                 |                |                 |                |                 |
| Output ON voltage drop        | 1.6 V (RMS) max.   |                 |                 |                 |                 |                |                 |                 | 1.8 V (RMS) max.        |                 |                 |                 |                |                 |                |                 |
| Leakage current *             | 10 mA max. (at 200 VAC)  |                 |                 |                 |                 |                |                 |                 | 20 mA max. (at 480 VAC) |                 |                 |                 |                |                 |                |                 |
| Insulation resistance         | 100 MΩ min. (at 500 VDC)   |                 |                 |                 |                 |                |                 |                 |                         |                 |                 |                 |                |                 |                |                 |
| Dielectric strength           | 2,500 VAC, 50/60 Hz for 1 min  |                 |                 |                 |                 |                |                 |                 |                         |                 |                 |                 |                |                 |                |                 |
| Vibration resistance          | <ul style="list-style-type: none"> <li>DIN Track mounting: 10 to 55 to 10 Hz, 0.175-mm single amplitude (0.35-mm double amplitude)</li> <li>Screw mounting: 10 to 55 to 10 Hz, 0.375-mm single amplitude (0.75-mm double amplitude)</li> </ul> |                 |                 |                 |                 |                |                 |                 |                         |                 |                 |                 |                |                 |                |                 |
| Shock resistance              | 294 m/s <sup>2</sup> (reverse mounting: 98 m/s <sup>2</sup> )  |                 |                 |                 |                 |                |                 |                 |                         |                 |                 |                 |                |                 |                |                 |
| Ambient storage temperature   | -30 to 100°C (with no icing or condensation)   |                 |                 |                 |                 |                |                 |                 |                         |                 |                 |                 |                |                 |                |                 |
| Ambient operating temperature | -30 to 80°C (with no icing or condensation)  |                 |                 |                 |                 |                |                 |                 |                         |                 |                 |                 |                |                 |                |                 |
| Ambient operating humidity    | 45% to 85%   |                 |                 |                 |                 |                |                 |                 |                         |                 |                 |                 |                |                 |                |                 |
| Weight                        | Approx. 1.25 kg  | Approx. 1.45 kg | Approx. 1.25 kg | Approx. 1.65 kg | Approx. 1.45 kg | Approx. 2.0 kg | Approx. 1.65 kg | Approx. 1.25 kg | Approx. 1.45 kg         | Approx. 1.25 kg | Approx. 1.65 kg | Approx. 1.45 kg | Approx. 2.0 kg | Approx. 1.65 kg | Approx. 2.0 kg | Approx. 1.65 kg |

\* The leakage current of phase S will be approximately  $\sqrt{3}$  times larger if the 2-element model is used.

### Models with Externally Attached Heat Sinks

| Model                         | G3PE-215B-3H  | G3PE-215B-2H | G3PE-225B-3H | G3PE-225B-2H | G3PE-235B-3H | G3PE-235B-2H | G3PE-245B-3H | G3PE-245B-2H | G3PE-515B-3H            | G3PE-515B-2H | G3PE-525B-3H | G3PE-525B-2H | G3PE-535B-3H | G3PE-535B-2H | G3PE-545B-3H | G3PE-545B-2H |
|-------------------------------|---|--------------|--------------|--------------|--------------|--------------|--------------|--------------|-------------------------|--------------|--------------|--------------|--------------|--------------|--------------|--------------|
| Operate time                  | 1/2 of load power source cycle + 1 ms max.                              |              |              |              |              |              |              |              |                         |              |              |              |              |              |              |              |
| Release time                  | 1/2 of load power source cycle + 1 ms max.                              |              |              |              |              |              |              |              |                         |              |              |              |              |              |              |              |
| Output ON voltage drop        | 1.6 V (RMS) max.  |              |              |              |              |              |              |              | 1.8 V (RMS) max.        |              |              |              |              |              |              |              |
| Leakage current *             | 10 mA max. (at 200 VAC)   |              |              |              |              |              |              |              | 20 mA max. (at 480 VAC) |              |              |              |              |              |              |              |
| Insulation resistance         | 100 MΩ min. (at 500 VDC)  |              |              |              |              |              |              |              |                         |              |              |              |              |              |              |              |
| Dielectric strength           | 2,500 VAC, 50/60 Hz for 1 min   |              |              |              |              |              |              |              |                         |              |              |              |              |              |              |              |
| Vibration resistance          | 10 to 55 to 10 Hz, 0.375-mm single amplitude (0.75-mm double amplitude) |              |              |              |              |              |              |              |                         |              |              |              |              |              |              |              |
| Shock resistance              | Destruction: 294 m/s <sup>2</sup>                                       |              |              |              |              |              |              |              |                         |              |              |              |              |              |              |              |
| Ambient storage temperature   | -30 to 100°C (with no icing or condensation)                            |              |              |              |              |              |              |              |                         |              |              |              |              |              |              |              |
| Ambient operating temperature | -30 to 80°C (with no icing or condensation)                             |              |              |              |              |              |              |              |                         |              |              |              |              |              |              |              |
| Ambient operating humidity    | 45% to 85%  |              |              |              |              |              |              |              |                         |              |              |              |              |              |              |              |
| Weight                        | Approx. 300 g   |              |              |              |              |              |              |              |                         |              |              |              |              |              |              |              |

\* The leakage current of phase S will be approximately  $\sqrt{3}$  times larger if the 2-element model is used.

### Heat Sinks

| Model     | Weight          |
|-----------|-----------------|
| Y92B-P50  | Approx. 450 g   |
| Y92B-P100 | Approx. 450 g   |
| Y92B-P150 | Approx. 600 g   |
| Y92B-P200 | Approx. 850 g   |
| Y92B-P250 | Approx. 1,200 g |

# G3PE-Three-phase

## Engineering Data

### Input Voltage vs. Input Impedance and Input Voltage vs. Input Current

G3PE-2□□B-□□

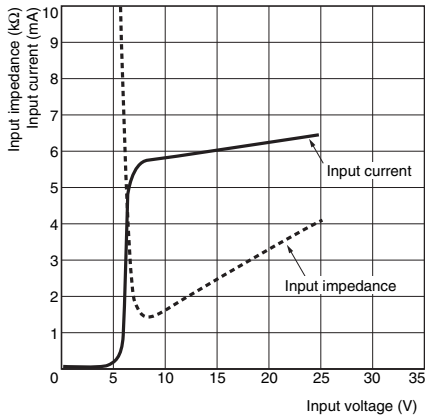

G3PE-5□□B-□□

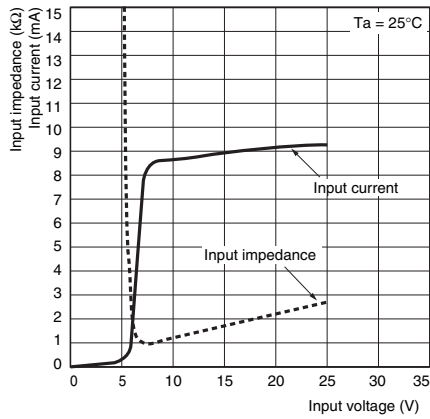

### Load Current vs. Ambient Temperature

#### Models with Built-in Heat Sinks

G3PE-215B-3(N), G3PE-225B-3(N)

G3PE-215B-2(N), G3PE-225B-2(N)

G3PE-515B-3(N), G3PE-525B-3(N)

G3PE-515B-2(N), G3PE-525B-2(N)

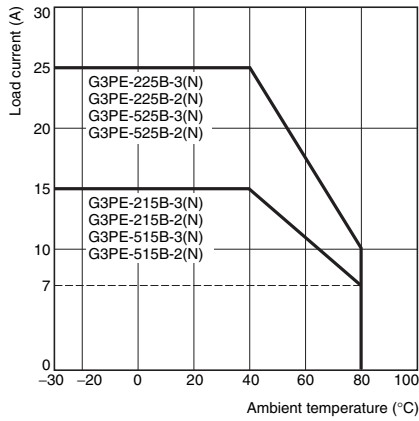

G3PE-235B-3(N), G3PE-245B-3(N)

G3PE-235B-2(N), G3PE-245B-2(N)

G3PE-535B-3(N), G3PE-545B-3(N)

G3PE-535B-2(N), G3PE-545B-2(N)

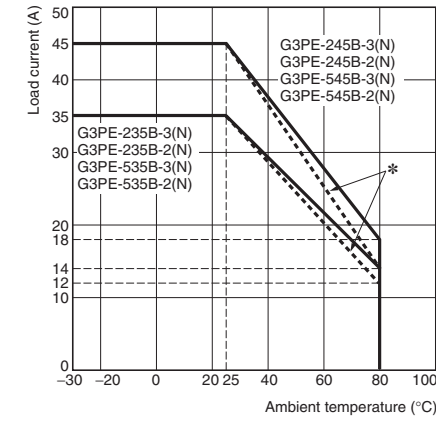

\* The dotted lines in the charts are the UL derating curves for the G3PE-235B-3(N), G3PE-245B-3(N), G3PE-235B-2(N), G3PE-245B-2(N), G3PE-535B-3(N), G3PE-545B-3(N), G3PE-535B-2(N), G3PE-545B-2(N).

#### Models with Externally Attached Heat Sinks

G3PE-215B-3H(-2H)

G3PE-225B-3H(-2H)

G3PE-515B-3H(-2H)

G3PE-525B-3H(-2H)

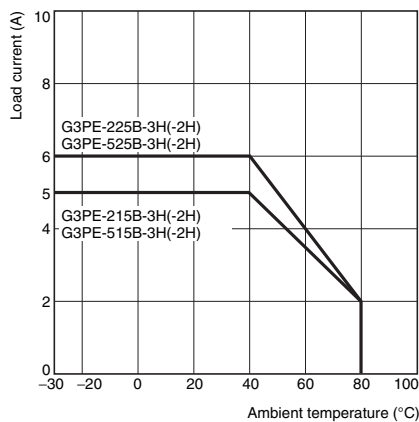

G3PE-235B-3H(-2H)

G3PE-245B-3H(-2H)

G3PE-535B-3H(-2H)

G3PE-545B-3H(-2H)

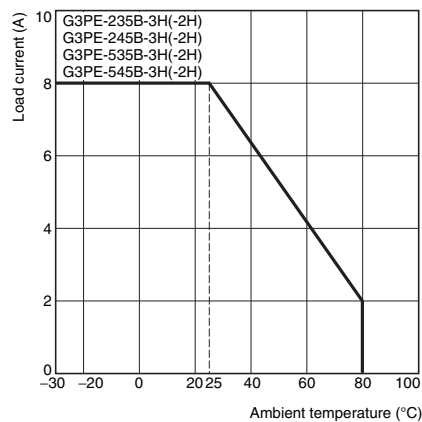

## Inrush Current Resistance: Non-repetitive

Keep the inrush current to below the inrush current resistance value (i.e., below the broken line) if it occurs repetitively.

G3PE-215B-3(N)(H)  
G3PE-215B-2(N)(H)

G3PE-225B-3(N)(H), G3PE-525B-3(N)(H)  
G3PE-225B-2(N)(H), G3PE-525B-2(N)(H)  
G3PE-515B-3(N)(H),  
G3PE-515B-2(N)(H),

G3PE-235B-3(N)(H), G3PE-535B-3(N)(H)  
G3PE-235B-2(N)(H), G3PE-535B-2(N)(H)  
G3PE-245B-3(N)(H), G3PE-545B-3(N)(H)  
G3PE-245B-2(N)(H), G3PE-545B-2(N)(H)

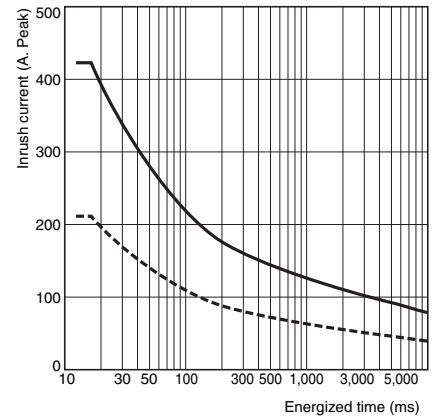
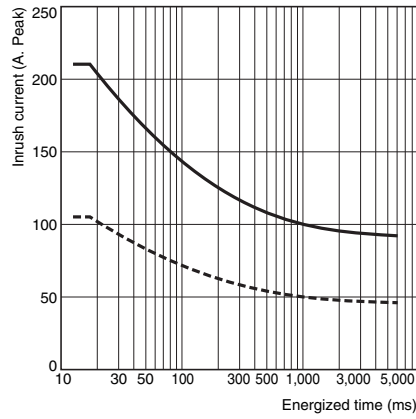
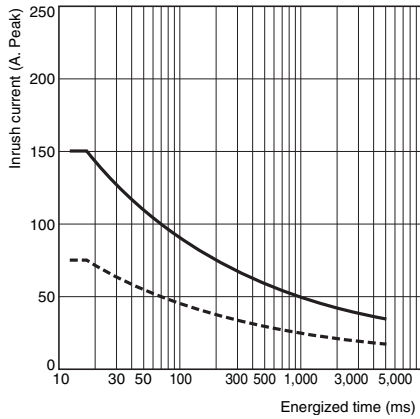

## Heat Sink Area vs. Load Current (40°C and 80°C)

G3PE-225B-3H

G3PE-525B-3H

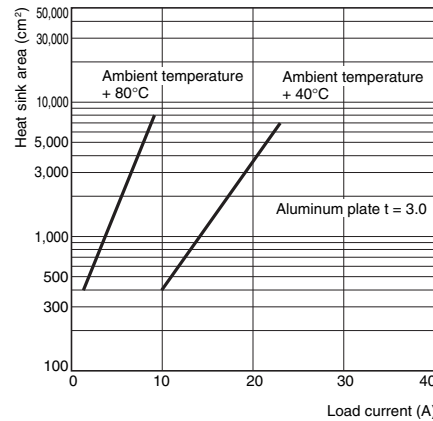
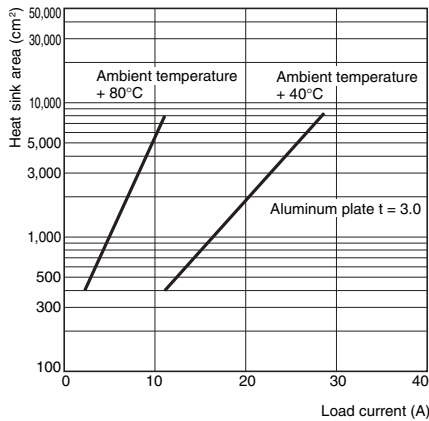

**Note:** The heat sink area is the combined area of all surfaces of the heat sink that radiate heat. For the G3PE-525B-3H, when a current of 18 A flows through the SSR at 40°C, the graph shows that a heat sink area of about 2,500 cm<sup>2</sup> would be required. Therefore, if the heat sink is square, one side of an aluminum plate in the heat sink must be 36 cm or longer ( $\sqrt{2,500 \text{ (cm}^2\text{)}/2} = 36 \text{ cm}$  (rounded to a whole number)).

## Models with Externally Attached Heat Sinks Heat Resistance R<sub>th</sub> (Junction/SSR Back Surface)

| Model        | R <sub>th</sub> (°C/W) |
|--------------|------------------------|
| G3PE-215B-3H | 1.05                   |
| G3PE-225B-3H | 0.57                   |
| G3PE-235B-3H | 0.57                   |
| G3PE-245B-3H | 0.57                   |

## Heat Resistance of Heat Sinks

| Model     | R <sub>th</sub> (°C/W) |
|-----------|------------------------|
| Y92B-P50  | 1.67                   |
| Y92B-P100 | 1.01                   |
| Y92B-P150 | 0.63                   |
| Y92B-P200 | 0.43                   |
| Y92B-P250 | 0.36                   |

**Note:** If a commercially available heat sink is used, use one that has a heat resistance equal to or lower than a standard OMRON Heat Sink.

# G3PE-Three-phase

## Dimensions

Note: All units are in millimeters unless otherwise indicated.

### Solid State Relays

#### Models with DIN Track Mounting

- G3PE-215B-3N
- G3PE-215B-2N
- G3PE-225B-2N
- G3PE-515B-3N
- G3PE-515B-2N
- G3PE-525B-2N

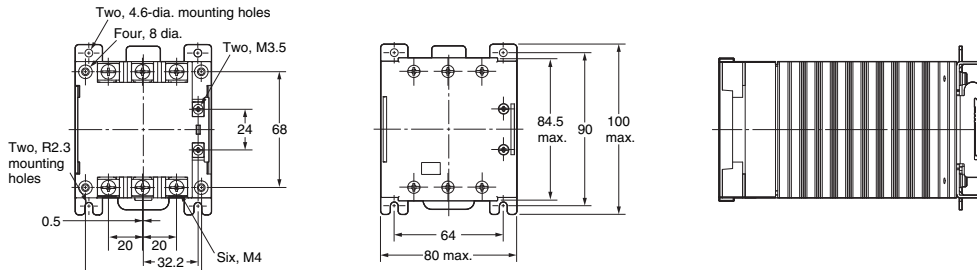

Note: Without terminal cover.

Note: With terminal cover.

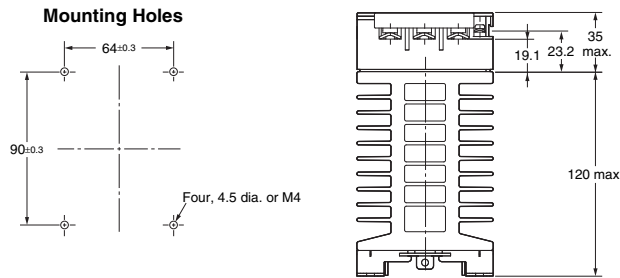

Terminal Arrangement/Internal Circuit Diagram

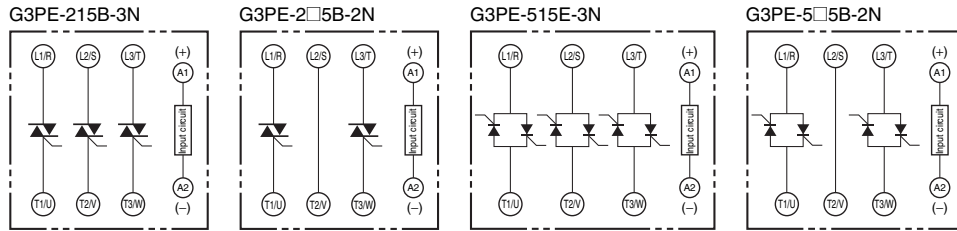

#### Models with DIN Track Mounting

- G3PE-225B-3N
- G3PE-235B-2N
- G3PE-525B-3N
- G3PE-535B-2N

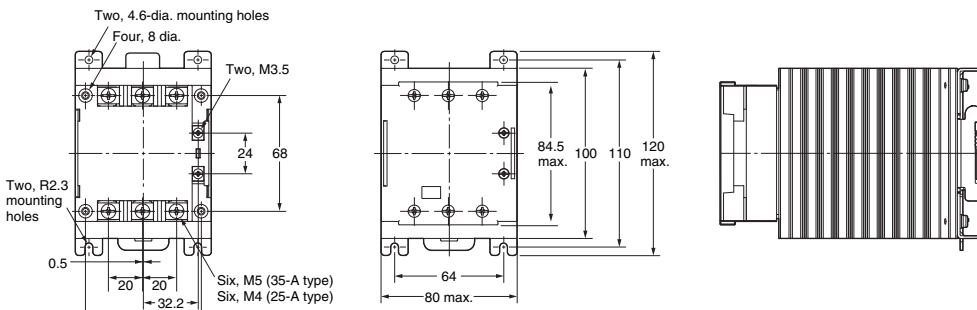

Note: Without terminal cover.

Note: With terminal cover.

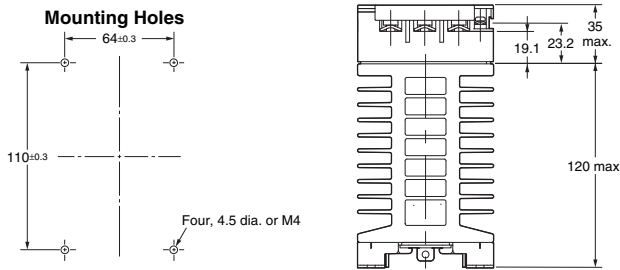

Terminal Arrangement/Internal Circuit Diagram

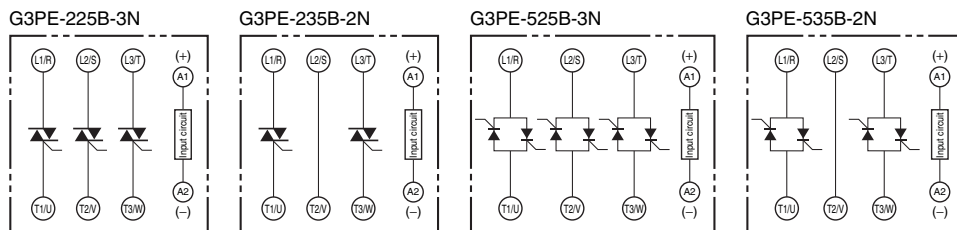

## Models with DIN Track Mounting

- G3PE-235B-3N
- G3PE-245B-2N
- G3PE-535B-3N
- G3PE-545B-2N

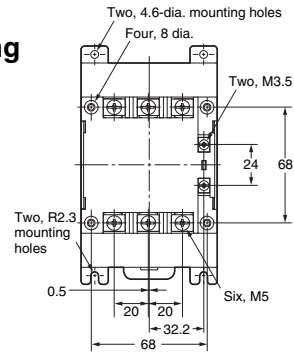

**Note:** Without terminal cover.

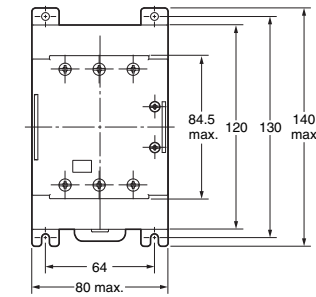

**Note:** With terminal cover.

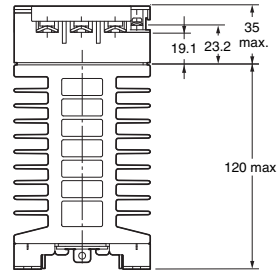
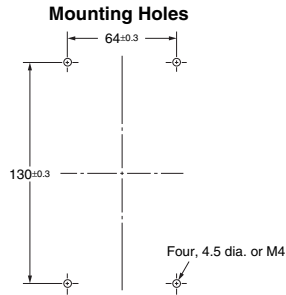
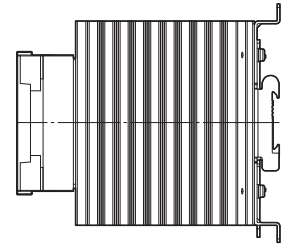

### Terminal Arrangement/Internal Circuit Diagram

G3PE-235B-3N

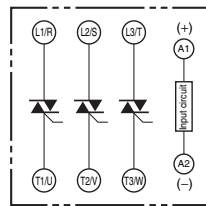

G3PE-245B-2N

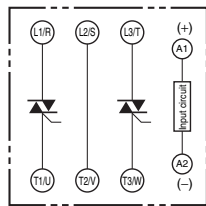

G3PE-535B-3N

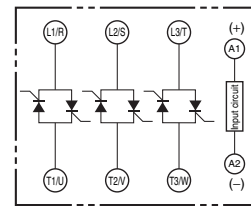

G3PE-545B-2N

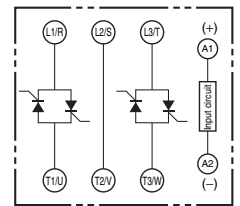

## Models with DIN Track Mounting

- G3PE-245B-3N
- G3PE-545B-3N

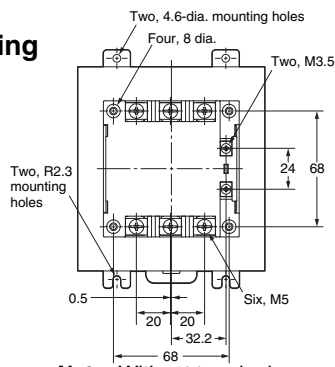

**Note:** Without terminal cover.

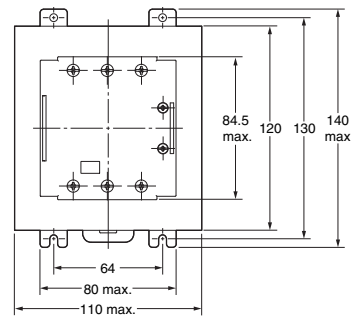

**Note:** With terminal cover.

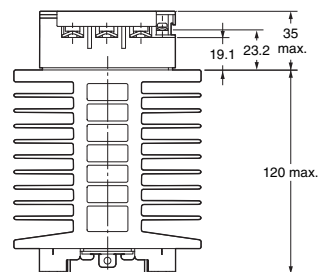
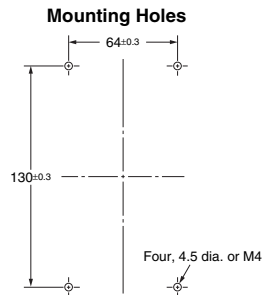
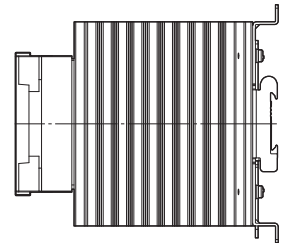

### Terminal Arrangement/Internal Circuit Diagram

G3PE245B-3N

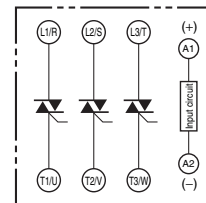

G3PE-545B-3N

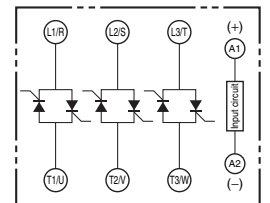

# G3PE-Three-phase

## Models with Screw Mounting

G3PE-215B-2  
G3PE-515B-2



DIN Track or screw mounting

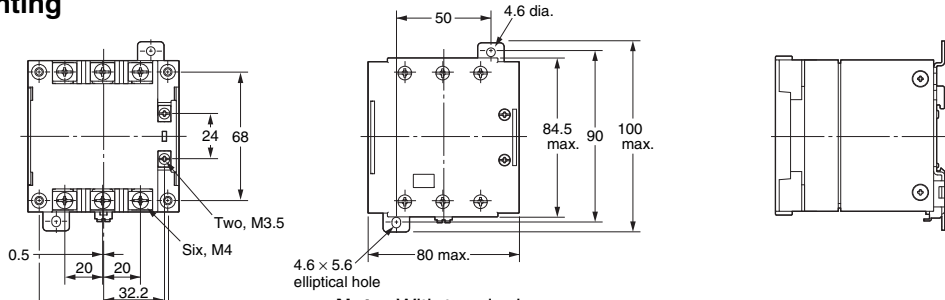

**Note:** Without terminal cover.

**Note:** With terminal cover.

### Mounting Holes

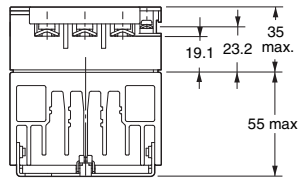
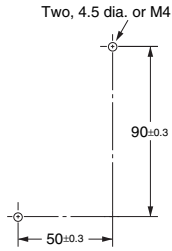

### Terminal Arrangement/Internal Circuit Diagram

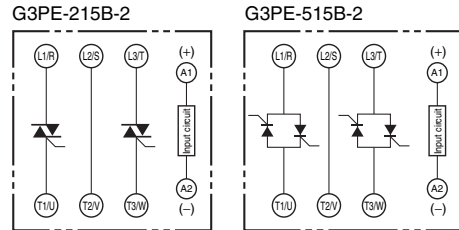

## Models with Screw Mounting

G3PE-215B-3  
G3PE-225B-2  
G3PE-515B-3  
G3PE-525B-2

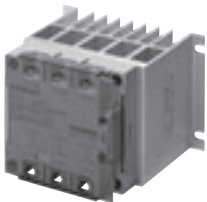

For screw mounting only

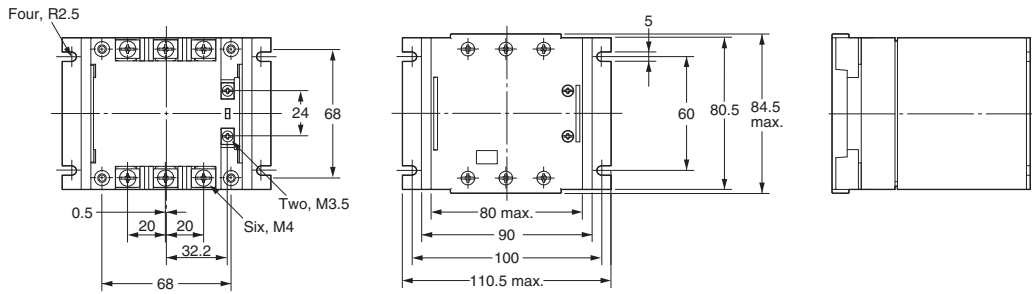

**Note:** Without terminal cover.

**Note:** With terminal cover.

### Mounting Holes

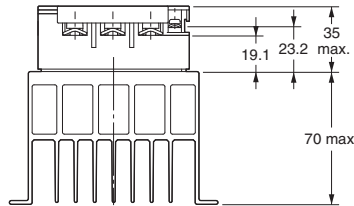
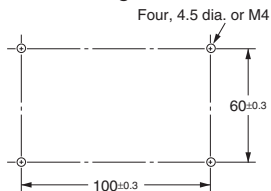

### Terminal Arrangement/Internal Circuit Diagram

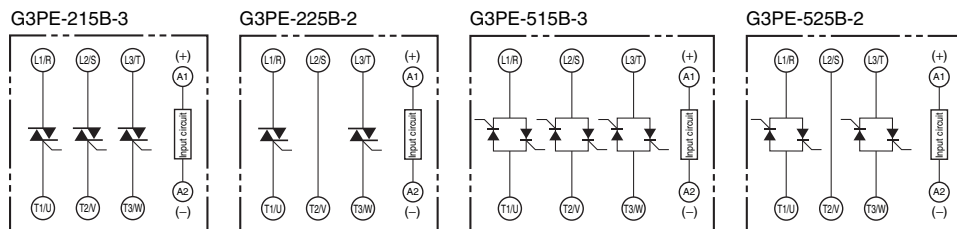

## Models with Screw Mounting

G3PE-225B-3  
G3PE-235B-2  
G3PE-525B-3  
G3PE-535B-2



For screw mounting only

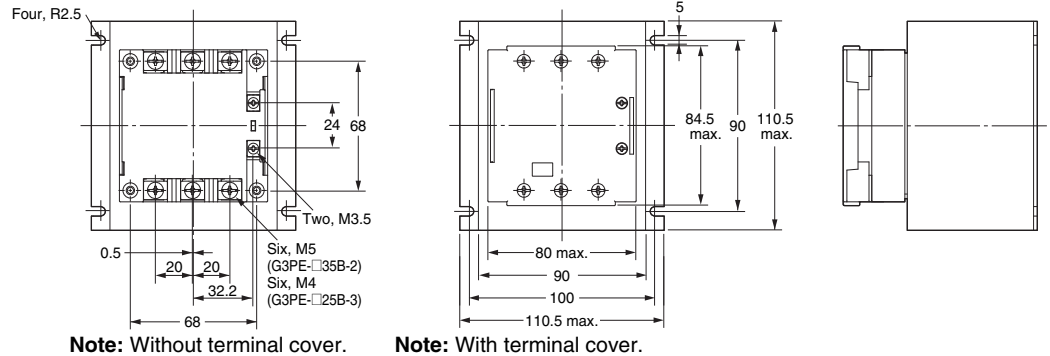

**Note:** Without terminal cover.

**Note:** With terminal cover.

### Mounting Holes

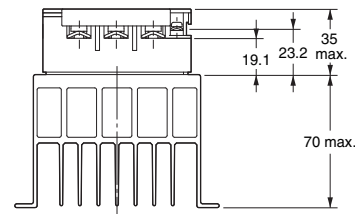
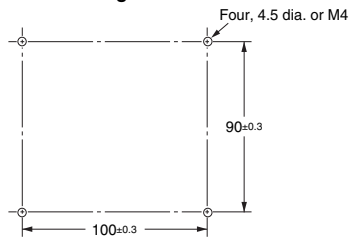

### Terminal Arrangement/Internal Circuit Diagram

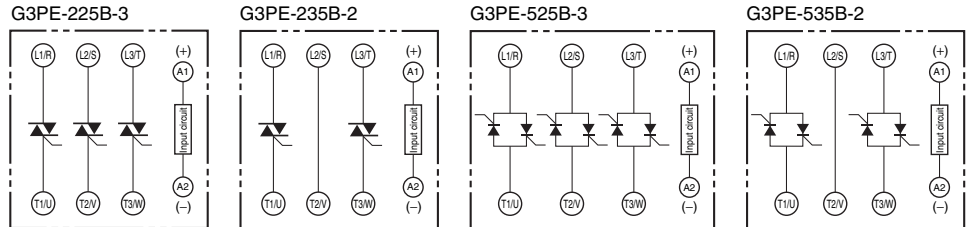

## Models with Screw Mounting

G3PE-235B-3  
G3PE-245B-2  
G3PE-535B-3  
G3PE-545B-2



For screw mounting only

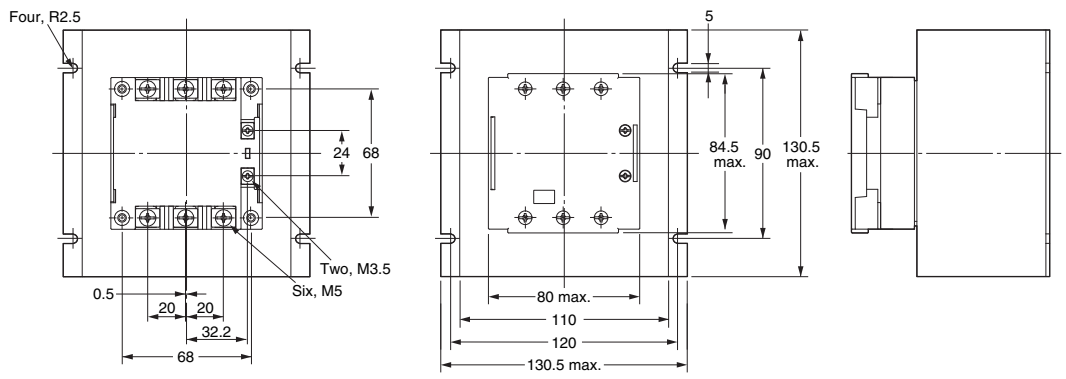

**Note:** Without terminal cover.

**Note:** With terminal cover.

### Mounting Holes

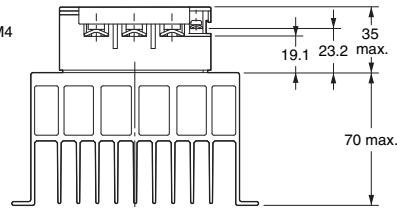
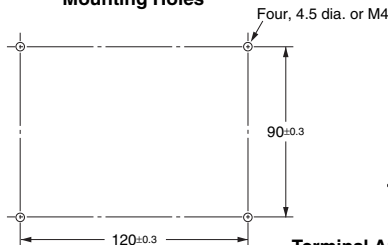

### Terminal Arrangement/Internal Circuit Diagram

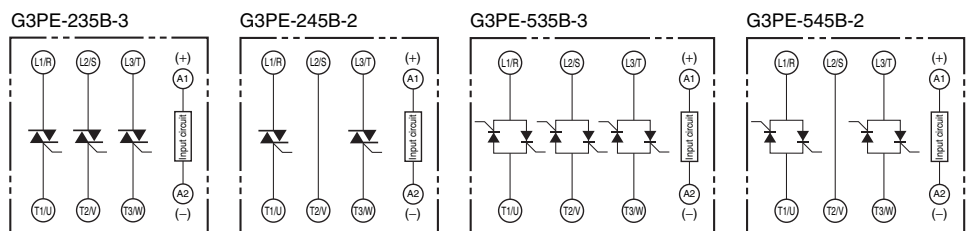

# G3PE-Three-phase

## Models with Screw Mounting

G3PE-245B-3  
G3PE-545B-3



For screw mounting only

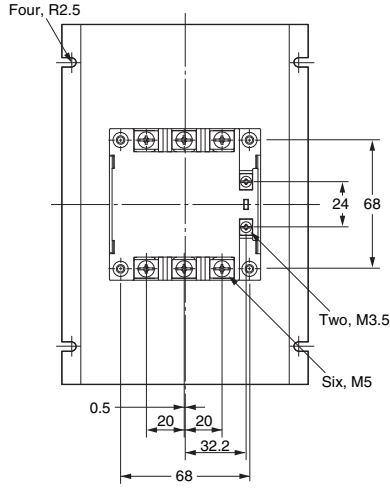

Note: Without terminal cover.

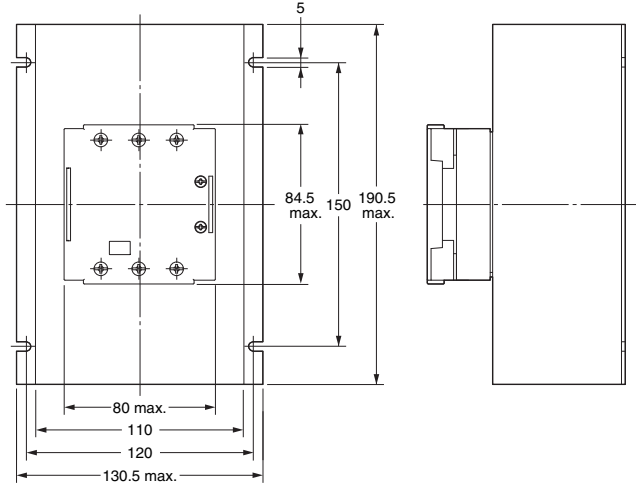

Note: With terminal cover.

### Mounting Holes

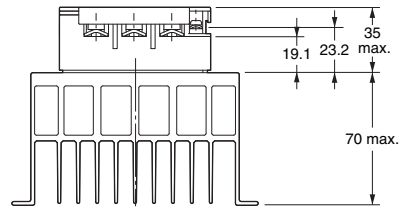
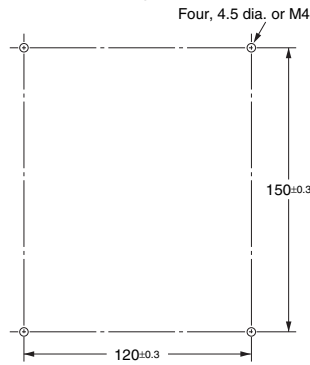

### Terminal Arrangement/Internal Circuit Diagram

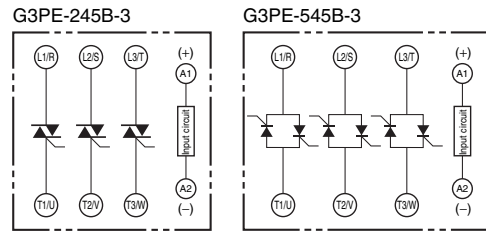

## Models with Externally Attached Heat Sinks

G3PE-215B-3H  
G3PE-215B-2H  
G3PE-225B-3H  
G3PE-225B-2H  
G3PE-235B-3H  
G3PE-235B-2H  
G3PE-245B-3H  
G3PE-245B-2H  
G3PE-515B-3H  
G3PE-515B-2H  
G3PE-525B-3H  
G3PE-525B-2H  
G3PE-535B-3H  
G3PE-535B-2H  
G3PE-545B-3H  
G3PE-545B-2H

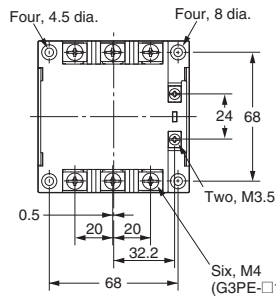

Note: Without terminal cover.

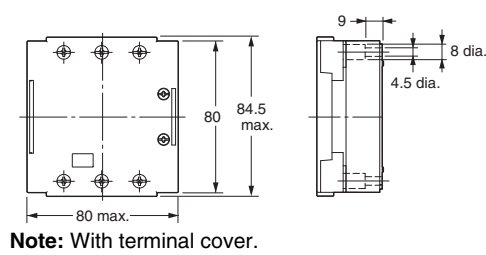

Note: With terminal cover.

### Mounting Holes

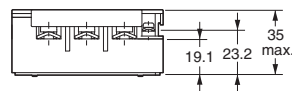
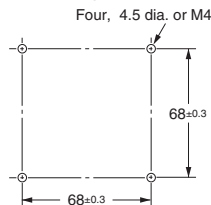

### Terminal Arrangement/Internal Circuit Diagram

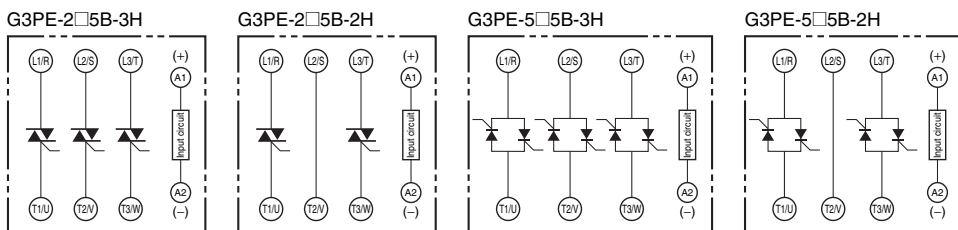



Accessories (Order Separately)

Heat Sink

Y92B-P50 (Mounts to DIN Track.)  
For G3PE-215B-2H and G3PE-515B-2H

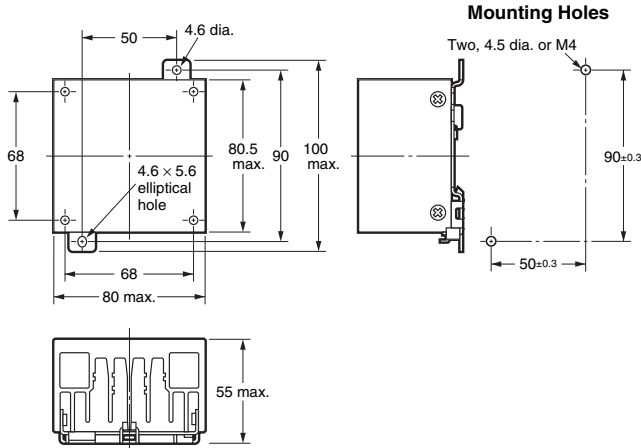

Heat Sink

Y92B-P100  
For G3PE-215B-3H, G3PE-225B-2H, G3PE-515B-3H, and G3PE-525B-2H

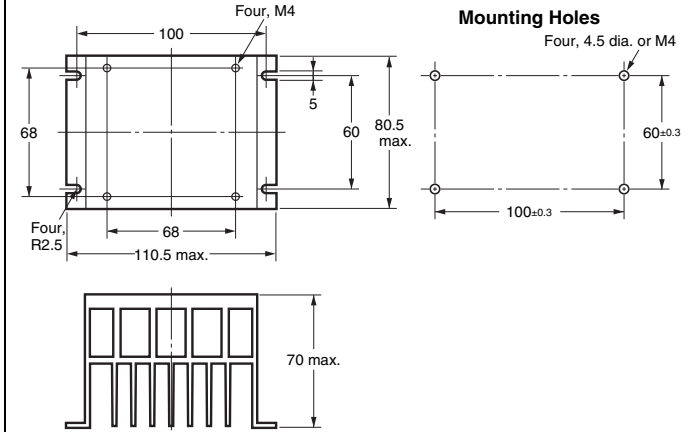

Heat Sink

Y92B-P150  
For G3PE-225B-3H, G3PE-235B-2H, G3PE-525B-3H, and G3PE-535B-2H

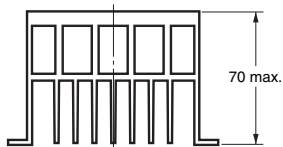
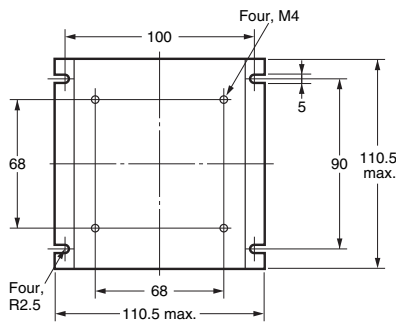

Mounting Holes

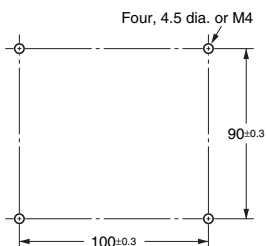

Heat Sink

Y92B-P200  
For G3PE-235B-3H, G3PE-245B-2H, G3PE-535B-3H, and G3PE-545B-2H

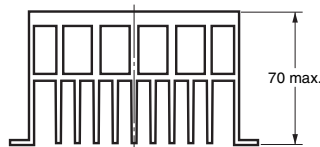
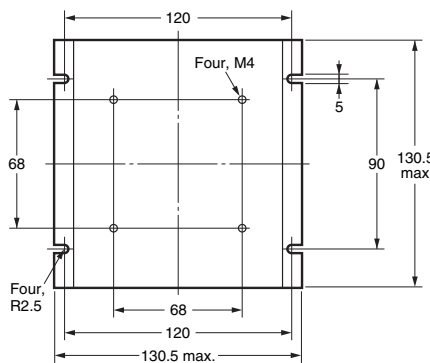

Mounting Holes

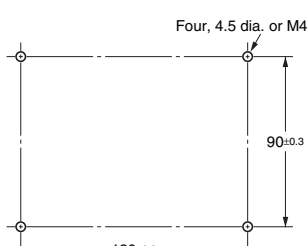

Heat Sink

Y92B-P250  
For G3PE-245B-3H and G3PE-545B-3H

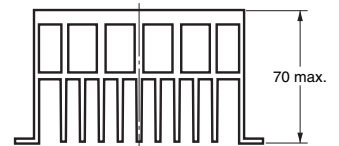
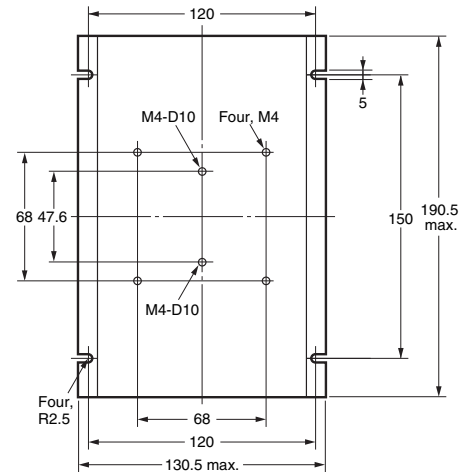

Mounting Holes

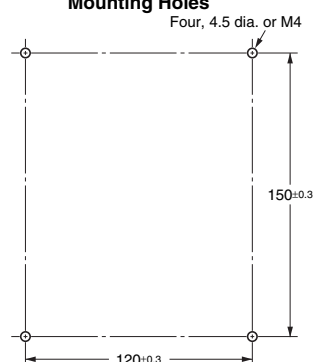

# Safety Precautions for All G3PE Models

For common precautions, refer to *Safety Precautions for All Solid-state Relays* on page 1191.

## CAUTION

Minor electrical shock may occasionally occur.

Do not touch the G3PE terminal section (i.e., current-carrying parts) while the power is being supplied. Also, always attach the cover terminal.



The G3PE may rupture if short-circuit current flows.

As protection against accidents due to short-circuiting, be sure to install protective devices, such as fuses and no-fuse breakers, on the power supply side.



Minor electrical shock may occasionally occur.

Do not touch the main circuit terminals on the G3PE immediately after the power supply has been turned OFF. Shock may result due to the electrical charge stored in the built-in snubber circuit.



Minor burns may occasionally occur.

Do not touch the G3PE or the heat sink while the power is being supplied or immediately after the power supply has been turned OFF. The G3PE and heat sink become extremely hot.



## Precautions for Safe Use

OMRON constantly strives to improve quality and reliability. SSRs, however, use semiconductors, and semiconductors may commonly malfunction or fail. In particular, it may not be possible to ensure safety if the SSRs are used outside the rated ranges. Therefore, always use the SSRs within the ratings. When using an SSR, always design the system to ensure safety and prevent human accidents, fires, and social harm in the event of SSR failure. System design must include measures such as system redundancy, measures to prevent fires from spreading, and designs to prevent malfunction.

### Transport

Do not transport the G3PE under the following conditions. Doing so may result in damage, malfunction, or deterioration of performance characteristics.

- Conditions in which the G3PE may be subject to water.
- Conditions in which the G3PE may be subject to high temperature or high humidity.
- Conditions in which the G3PE is not packaged.

### Operating and Storage Environments

Do not use or store the G3PE in the following locations. Doing so may result in damage, malfunction, or deterioration of performance characteristics.

- Locations subject to rainwater or water splashes.
- Locations subject to exposure to water, oil, or chemicals.
- Locations subject to high temperature or high humidity.
- Do not store in locations subject to ambient storage temperatures outside the range  $-30$  to  $100^{\circ}\text{C}$ .
- Do not use in locations subject to relative humidity outside the range 45% to 85%.
- Locations subject to corrosive gases.
- Locations subject to dust (especially iron dust) or salts.
- Locations subject to direct sunlight.
- Locations subject to shock or vibration.

## Installation and Handling

- Do not block the movement of the air surrounding the G3PE or heat sink. Abnormal heating of the G3PE may result in shorting failures of the output elements or burn damage.
- Do not use the G3PE if the heat radiation fins have been bent by being dropped. Doing so may result in malfunction due to a reduction in the heat radiation performance.
- Do not handle the G3PE with oily or dusty (especially iron dust) hands. Doing so may result in malfunction.
- Attach a heat sink or radiator when using an SSR. Not doing so may result in malfunction due to a reduction in the heat radiation performance.

## Installation and Mounting

- Mount the G3PE in the specified direction. Otherwise excessive heat generated by the G3PE may cause short-circuit failures of the output elements or burn damage.
- Make sure that there is no excess ambient temperature rise due to the heat generation of the G3PE. If the G3PE is mounted inside a panel, install a fan so that the interior of the panel is fully ventilated.
- Make sure the DIN track is securely mounted. Otherwise, the G3PE may fall.
- When mounting the heat sink, do not allow any foreign matter between the heat sink and the mounting surface. Foreign matter may cause malfunction due to a reduction in the heat radiation performance.
- If the G3PE is mounted directly in a control panel, use aluminum, steel plating, or similar material with a low heat resistance as a substitute for a heat sink. Using the G3PE mounted in wood or other material with a high heat resistance may result in fire or burning due to heat generated by the G3PE.

## Installation and Wiring

- Use wires that are suited to the load current. Otherwise, excessive heat generated by the wires may cause burning.
- Do not use wires with a damaged outer covering. Otherwise, it may result in electric shock or ground leakage.
- Do not wire any wiring in the same duct or conduit as power or high-tension lines. Otherwise, inductive noise may damage the G3PE or cause it to malfunction.
- When tightening terminal screws, prevent any non-conducting material from becoming caught between the screws and the tightening surface. Otherwise, excessive heat generated by the terminal may cause burning.
- Do not use the G3PE with loose terminal screws. Otherwise, excessive heat generated by the wire may cause burning.
- For the G3PE models with a carry current of 35 A or larger, use M5 crimp terminals that are an appropriate size for the diameter of the wire.
- Always turn OFF the power supply before performing wiring. Not doing so may cause electrical shock.

## Installation and Usage

- Select a load within the rated values. Not doing so may result in malfunction, failure, or burning.
- Select a power supply within the rated frequencies. Not doing so may result in malfunction, failure, or burning.
- If a surge voltage is applied to the load of the Contactor, a surge bypass(\*) will function to trigger the output element. The G3PE therefore cannot be used for motor loads. Doing so may result in load motor malfunction.

### \* Surge Bypass

This circuit protects the output circuit from being destroyed. This suppresses the surge energy applied inside the SSR in comparison with a varistor for the main circuit protection. By alleviating electrical stress on the electronic components of the SSR's output circuit, failure and destruction due to surge voltage are suppressed.

Reference value: Surge dielectric strength of 30 kV min.  
(Test conditions:  $1.2 \times 50 \mu\text{s}$  standard voltage waveform, peak voltage of 30 kV, repeated 50 times according to JIS C5442)

## Precautions for Correct Use

The SSR in operation may cause an unexpected accident. Therefore it is necessary to test the SSR under the variety of conditions that are possible. As for the characteristics of the SSR, it is necessary to consider differences in characteristics between individual SSRs.

The ratings in this catalog are tested values in a temperature range between 15°C and 30°C, a relative humidity range between 25% and 85%, and an atmospheric pressure range between 86 and 106 kPa. It will be necessary to provide the above conditions as well as the load conditions if the user wants to confirm the ratings of specific SSRs.

## Causes of Failure

- Do not drop the G3PE or subject it to abnormal vibration or shock during transportation or mounting. Doing so may result in deterioration of performance, malfunction, or failure.
- Tighten each terminal to the torque specified below. Improper tightening may result in abnormal heat generation at the terminal, which may cause burning.

| Terminals        | Screw terminal diameter | Tightening torque |
|------------------|-------------------------|-------------------|
| Input terminals  | M3.5                    | 0.59 to 1.18 N·m  |
| Output terminals | M4                      | 0.98 to 1.47 N·m  |
|                  | M5                      | 1.57 to 2.45 N·m  |

- Do not supply overvoltage to the input circuits or output circuits. Doing so may result in failure or burning.
- Do not use or store the G3PE in the following conditions. Doing so may result in deterioration of performance.
  - Locations subject to static electricity or noise
  - Locations subject to strong electric or magnetic fields
  - Locations subject to radioactivity

## Mounting

- The G3PE is heavy. Firmly mount the DIN Track and secure both ends with End Plates for DIN Track mounting models. When mounting the G3PE directly to a panel, firmly secure it to the panel.

Screw diameter: M4

Tightening torque: 0.98 to 1.47 N·m

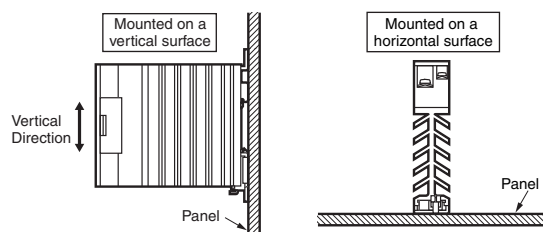

**Note:** Make sure that the load current is 50% of the rated load current when the G3PE is mounted horizontally.

For details on close mounting, refer to the related information under performance characteristics.

Mount the G3PE in a direction so that the markings read naturally.

- The G3PE-2N/-3N (DIN Track mounting models) can be mounted on the following TR35-15Fe (IEC 60715) DIN Tracks.

| Manufacturer | Thickness | 1.5 mm              | 2.3 mm      |
|--------------|-----------|---------------------|-------------|
| Schneider    |           | AM1-DE200           | ---         |
| WAGO         |           | 210-114,<br>210-197 | 210-118     |
| PHOENIX      |           | NS35/15             | NS35/15-2.3 |

## Wiring

- When using crimp terminals, refer to the terminal clearances shown below.

### Output Terminal Section for Three-phase Models

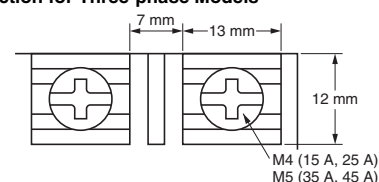

### Output Terminal Section for Single-phase Models

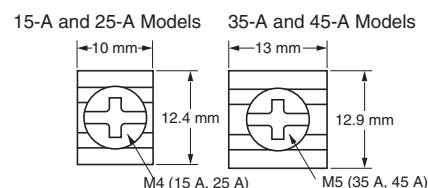

### Input Terminal Section

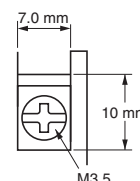

- Make sure that all lead wires are thick enough for the current.
- For three-element and two-element models, the output terminal will be charged even when the Relay is OFF. Touching the terminal may result in electric shock. To isolate the Relay from the power supply, install an appropriate circuit breaker between the power supply and the Relay.

Always turn OFF the power supply before wiring the Unit.

- Terminal L2 and terminal T2 of a 2-element model are internally connected to each other. Connect terminal L2 to the ground terminal of the power supply. If terminal L2 is connected to a terminal other than the ground terminal, cover all the charged terminals, such as heater terminals, to prevent electric shock and ground faults.

## Fuses

- Use a quick-burning fuse on the output terminals to prevent accidents due to short-circuiting. Use a fuse with equal or greater performance than those given in the following table.

### Recommended Fuse Capacity

| Rated G3PE output current | Applicable SSR  | Fuse (IEC 60269-4) |
|---------------------------|-----------------|--------------------|
| 15 A                      | G3PE□15B Series | 32 A               |
| 25 A                      | G3PE□25B Series |                    |
| 35 A                      | G3PE□35B Series | 63 A               |
| 45 A                      | G3PE□45B Series |                    |

## EMC Ditective Compliance

EMC direcives can be complied with under the following conditions.

### 1. Single phase 240V (2□□B) models

- A capacitor must be connected to the load power supply.
- The input cable must be less than 3 m.

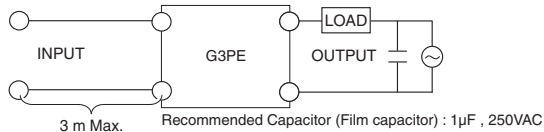

### 2. Single phase 480V (5□□B) models

- A capacitor must be connected to the input power supply.
- A capacitor, varistor and toroidal core must be connected to the load power supply.
- The input cable must be less than 3 m.

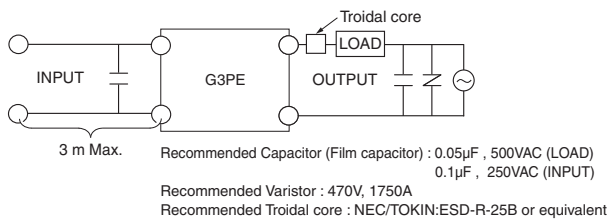

### 3. Three phases models

- A capacitor must be connected to the input power supply.
- A capacitor and toroidal core must be connected to the load power supply.
- The input cable must be less than 3 m.

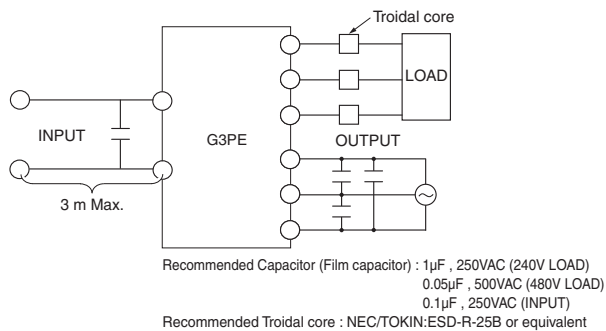

## EMI

This is a Class A product (for industrial environments). In a domestic environment, the G3PE may cause radio interference, in which case the user may be required to take appropriate measures.

## Noise and Surge Effects

If noise or an electrical surge occurs that exceeds the malfunction withstand limit for the G3PE output circuit, the output will turn ON for a maximum of one half cycle to absorb the noise or surge. Confirm that turning the output ON for a half cycle will not cause a problem for the device or system in which the G3PE is being used prior to actual use. The G3PE malfunction withstand limit is shown below.

- Malfunction withstand limit (reference value): 500 V

**Note:** This value was measured under the following conditions.

Noise duration: 100 ns and 1 µs  
Repetition period: 100 Hz  
Noise application time: 3 min

## Mounting Models with Externally Attached Heat Sinks

- Before attaching an external Heat Sink or Radiator to the Unit, always apply silicone grease, such as Momentive Performance Material's YG6260 or Shin-Etsu Chemical's G747, to the mounting surface to enable proper heat radiation.
- Tighten the screws to the following torque to secure the Unit and external Heat Sink or Radiator to enable proper heat dissipation. Tightening torque: 2.0 N·m

## Mounting to Control Panel

The G3PE is heavy. Firmly mount the DIN track and secure both ends with End Plates for DIN-track-mounting models. When mounting the G3PE directly to a panel, firmly secure it to the panel.

If the panel is airtight, heat from the SSR will build up inside, which may reduce the current carry ability of the SSR or adversely affect other electrical devices. Be sure to install ventilation holes on the top and bottom of the panel.

## SSR Mounting Pitch (Panel Mounting)

- Single-phase Model

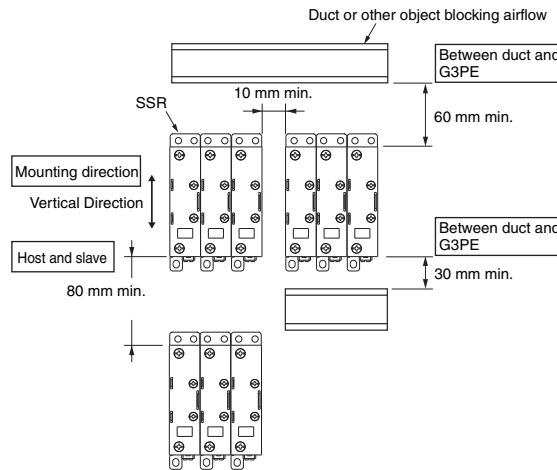

- Three-phase Models

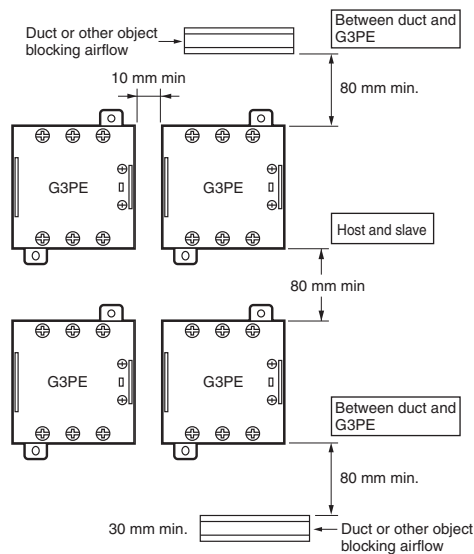

## Relationship between the G3PE and Ducts or Other Objects Blocking Airflow

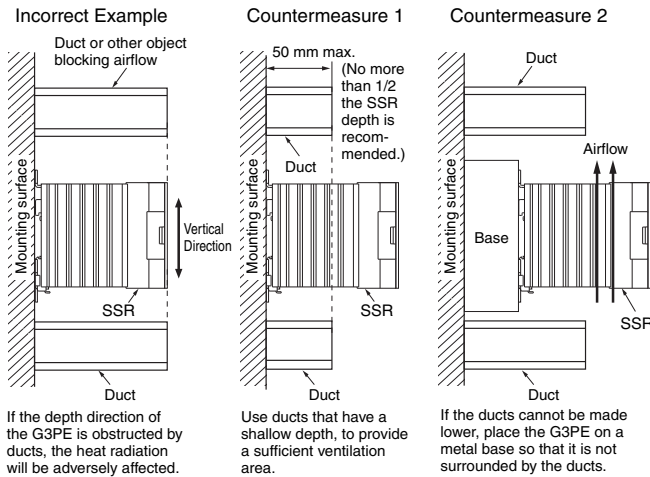

## Ventilation Outside the Control Panel

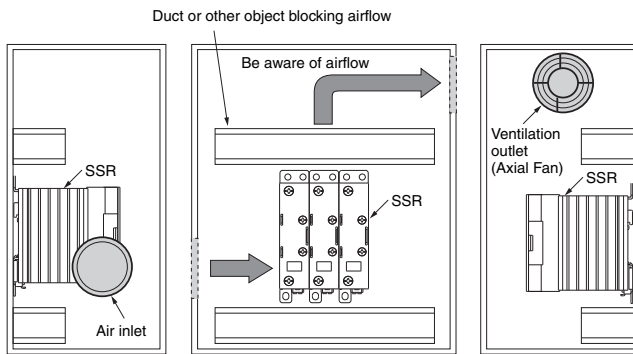

- Note:**
1. If the air inlet or air outlet has a filter, clean the filter regularly to prevent it from clogging to ensure an efficient flow of air.
  2. Do not locate any objects around the air inlet or air outlet, otherwise the objects may obstruct the proper ventilation of the control panel.
  3. A heat exchanger, if used, should be located in front of the G3PE to ensure the efficiency of the heat exchanger.

## G3PE Ambient Temperature

The rated current of the G3PE is measured at an ambient temperature of 40°C.

The G3PE uses a semiconductor to switch the load. This causes the temperature inside the control panel to increase due to heating resulting from the flow of electrical current through the load. The G3PE reliability can be increased by adding a ventilation fan to the control panel to dispel this heat, thus lowering the ambient temperature of the G3PE.

(Arrhenius's law suggests that life expectancy is doubled by each 10°C reduction in ambient temperature.)

| SSR rated current (A)           | 15 A | 25 A | 35 A | 45 A |
|---------------------------------|------|------|------|------|
| Required number of fans per SSR | 0.23 | 0.39 | 0.54 | 0.70 |

Example: For 10 G3PE SSRs with load currents of 15 A,  
 $0.23 \times 10 = 2.3$

Thus, 3 fans would be required.

- Note:**
1. Size of fans: 92 mm × 92 mm, Air volume: 0.7 m<sup>3</sup>/min, Ambient temperature of control panel: 30°C
  2. If there are other instruments that generate heat in the control panel in addition to SSRs, more ventilation will be required.
  3. Ambient temperature: The temperature that will allow the SSR to cool by convection or other means.

Refer to the Service & Support on your OMRON website for technical descriptions and FAQs on the product.

# Solid State Relays Common Precautions

●For precautions on individual products, refer to "■Precautions" in individual product information.

## ⚠ CAUTION

Touching the charged section is likely to cause electric shock. Do not touch the SSR terminal section (the charged section) when the power supply is ON. For SSRs with terminal covers, be sure to attach the cover before use.



The SSR and heat sink will be hot and are likely to cause burns. Do not touch the SSR or the heat sink either while the power supply is ON, or immediately after the power is turned OFF.



The internal snubber circuit is charged and will cause electric shock. Do not touch the SSR load terminal immediately after the power is turned OFF.



Electric shock is likely to result. Be sure to conduct wiring with the power supply turned OFF.



SSRs may occasionally explode. Do not apply a short-circuit current to the load side of an SSR. To protect against short-circuit accidents, be sure to install a protective device, such as a quick-break fuse etc. on the power supply line.



## Safety Cautions

OMRON constantly strives to improve quality and reliability. SSRs, however, use semiconductors, and semiconductors may commonly malfunction or fail. Short-circuit failures represent the main failure mode and can result in an inability to shut OFF the load. Therefore, for fail-safe operation of control circuits that use SSRs, do not use circuits that shut OFF the load power supply only with an SSR, but rather also use circuits with a contactor or breaker that shuts off the load when the SSR fails. In particular, it may not be possible to ensure safety if the SSRs are used outside the rated ranges. Therefore, always use the SSRs within the ratings.

When using an SSR, always design the system to ensure safety and prevent human accidents, fires, and social harm in the event of SSR failure. System design must include measures such as system redundancy, measures to prevent fires from spreading, and designs to prevent malfunction.

1. Do not apply voltage or current in excess of the ratings to the terminals of the SSR. Doing so may result in failure or burn damage.
2. Heat Radiation
  - Be careful with the increase in ambient temperature caused by self-heating. Mount a fan etc. to provide a sufficient air ventilation especially in case of internal mounting.
  - Mount the SSR following the specified mounting orientation. The abnormal heat generation from the body may cause output elements to short or may cause burning.
3. Perform correct wiring following the precautions below. Improper wiring may lead to abnormal heating resulting in burn damage to the SSR once the power is supplied.
  - Use a suitable wire according to the load current. Otherwise the abnormal heating of the wire may cause burning.
4. Operating Conditions
  - Designate the load within the rated range. Otherwise it may result in faulty operation, malfunction, or burning.
  - Use a power supply within the rated frequency range. Otherwise it may result in faulty operation, malfunction, or burning.
5. Do not transport the SSR under the following conditions. Failure, malfunction, or deterioration of performance characteristics may occur.
  - Conditions under which the SSR will be exposed to water
  - High temperatures or high humidity
  - Without proper packing
6. Operating and Storage Environment  
Do not use or store the SSR in the following environments. Doing so may result in damage, malfunction, or deterioration of performance characteristics.

- Do not use or store in environments subject to exposure to sunlight.
- Do not use in environments subject to temperatures outside the range specified individually.
- Do not use in environments subject to relative humidity outside the range of 45% to 85% RH, or in locations subject to condensation as the result of severe changes in temperature.
- Do not store in environments subject to temperatures outside the range specified individually.
- Do not use or store in environments subject to corrosive or flammable gases.
- Do not use or store in environments subject to dust, salt, or iron dust, or in locations subject to salt damage.
- Do not use or store in environments subject to shock or vibration.
- Do not use or store in environments subject to exposure to water, oil, or chemicals, or in environments subject to exposure to rain and water splashes.
- Do not use or store in environments subject to high temperature or high humidity.

# Solid State Relays Common Precautions

## Precautions for Correct use

### ● Before Using SSR

- The SSR in operation may cause an unexpected accident. Therefore it is necessary to test the SSR under the variety of conditions that are possible.  
For example, as for the characteristics of the SSR, it is necessary to consider differences in characteristics between individual SSRs.
- The ratings in this catalog are tested values in a temperature range between 15°C and 30°C, a relative humidity range between 25% and 85%, and an atmospheric pressure range between 88 and 106 kPa. It will be necessary to provide the above conditions as well as the load conditions if the user wants to confirm the ratings of specific SSRs.

### ■ Input Circuit

#### ● Connecting to the Input Side

There is variation in the input impedance of SSRs. Therefore, do not connect multiple inputs in series. Otherwise malfunction may occur.

#### ● Input Noise

SSRs need only a small amount of power to operate. This is why the input terminals must shut out electrical noise as much as possible. Noise applied to the input terminals may result in malfunction. The following describes measures to be taken against pulse noise and inductive noise.

#### 1. Pulse Noise

A combination of capacitor and resistor can absorb pulse noise effectively. The following is an example of a noise absorption circuit with capacitor C and resistor R connected to an SSR incorporating a photocoupler.

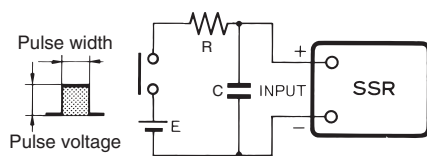

The value of R and C must be decided carefully. The value of R must not be too large or the supply voltage (E) will not be able to satisfy the required input voltage value. The larger the value of C is, the longer the release time will be, due to the time required for C to discharge electricity.

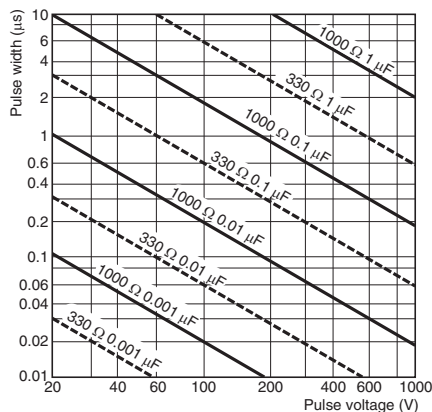

Note. For low-voltage models, sufficient voltage may not be applied to the SSR because of the relationship between C, R, and the internal impedance. When deciding on a value for R, check the input impedance for the SSR.

#### 2. Inductive Noise

Do not wire power lines alongside the input lines. Inductive noise may cause the SSR to malfunction. If inductive noise is imposed on the input terminals of the SSR, use the following cables according to the type of inductive noise, and reduce the noise level to less than the must release voltage of the SSR.

Twisted-pair wire: For electromagnetic noise

Shielded cable: For static noise

A filter consisting of a combination of capacitor and resistor will effectively reduce noise generated from high-frequency equipment.

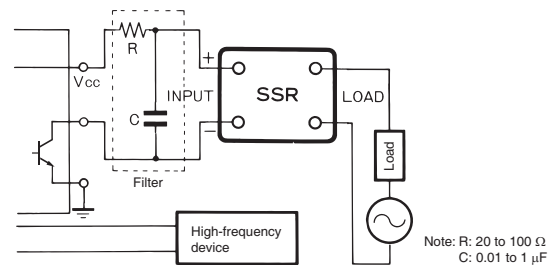

#### ● Input Conditions

##### 1. Input Voltage Ripples

When there is a ripple in the input voltage, set the input voltage so that the peak voltage is lower than the maximum operating voltage and the root voltage is above the minimum operating voltage.



##### 2. Countermeasures for Leakage Current

When the SSR is powered by transistor output, the must release voltage may be insufficient due to leakage current while power is OFF. To counteract this, connect bleeder resistance as shown in the diagram below and set the bleeder resistance so that VR is half of the release voltage or less.

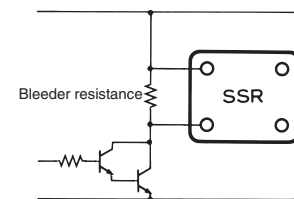

The bleeder resistance R can be obtained in the way shown below.

$$R \leq \frac{E}{I_L - I}$$

E : Voltage applied at both ends of the bleeder resistance = half of the release voltage of the SSR

$I_L$  : Leakage current of the transistor

I : Release voltage of SSR

The actual value of the release current is not given in the datasheet and so when calculating the value of the bleeder resistance, use the following formula.

$$\text{Release current for SSR} = \frac{\text{Minimum value of release voltage}}{\text{Input impedance}}$$

For SSRs with constant-current input circuits, calculation is performed at 0.1 mA.

The calculation for the G3M-202P DC24 is shown below as an example.

$$\text{Release current } I = \frac{1 \text{ V}}{1.6 \text{ k}\Omega} = 0.625 \text{ mA}$$

$$\text{Bleeder resistance } R = \frac{1\text{V} \times 1/2}{I_L - 0.625 \text{ mA}}$$

# Solid State Relays Common Precautions

## 3. ON/OFF Frequency

An SSR has delay times called the operating time and release time. Loads, such as inductive loads, also have delay times called the operating time and release time. These delays must all be considered when determining the switching frequency.

## 4. Input impedance

In SSRs which have wide input voltages (such as G3CN and G3TB), the input impedance varies according to the input voltage and changes in the input current.

For semiconductor-driven SSRs, changes in voltage can cause malfunction of the semiconductor, so be sure to check by the actual device before usage.

See the following examples.

### Input impedance (Example) G3CN

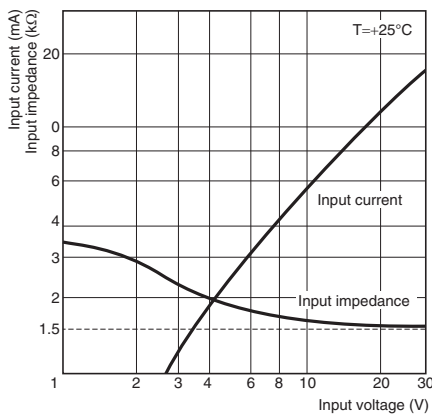

## Output Circuit

### AC Switching SSR Output Noise and Surges

- In case there is a large voltage surge in the AC current being used by the SSR, the RC snubber circuit built into the SSR between the SSR load terminals will not be sufficient to suppress the surge, and the SSR transient peak element voltage will be exceeded, causing overvoltage damage to the SSR.
- Only the following models have a built-in surge absorbing varistor: G3NA, G3S, G3PA, G3NE, G3PH, G3DZ (some models), G3RZ, and G3FM. When switching an inductive load with any other models, be sure to take countermeasures against surge, such as adding a surge absorbing element.
- In the following example, a surge voltage absorbing element has been added.

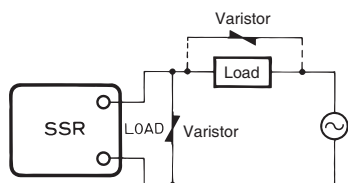

Select an element which meets the conditions in the following table as the surge absorbing element.

| Voltage        | Varistor voltage | Surge resistance |
|----------------|------------------|------------------|
| 100 to 120 VAC | 240 to 270 V     | 1,000 A min.     |
| 200 to 240 VAC | 440 to 470 V     |                  |
| 380 to 480 VAC | 820 to 1,000 V   |                  |

### Output Connections

Do not connect SSR outputs in parallel. With SSRs, both sides of the output will not turn ON at the same time, so the load current cannot be increased by using parallel connections.

### DC Switching SSR Output Noise Surges

When an L load, such as a solenoid or electromagnetic valve, is connected, a diode that prevents counter-electromotive force. If the counter-electromotive force exceeds the withstand voltage of the SSR output element, it could result in damage to the SSR output element. To prevent this, insert the element parallel to the load, as shown in the following diagram and table.

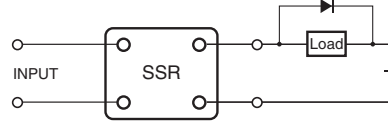

As an absorption element, the diode is the most effective at suppressing the counter-electromotive force. The release time for the solenoid or electromagnetic valve will, however, increase. Be sure to check the circuit before use. To shorten the time, connect a Zener diode and a regular diode in series. The release time will be shortened at the same rate that the Zener voltage ( $V_z$ ) of the Zener diode is increased.

Table 1. Absorption Element Example

| Absorption element |       |                     |          |    |
|--------------------|-------|---------------------|----------|----|
|                    | Diode | Diode + Zener diode | Varistor | CR |
| Effectiveness      | ○     | ○                   | △        | ×  |

(Reference)

#### 1. Selecting a Diode

$$\text{Withstand voltage} = V_{RM} \geq \text{Power supply voltage} \times 2$$

$$\text{Forward current} = I_F \geq \text{load current}$$

#### 2. Selecting a Zener Diode

$$\text{Zener voltage} = V_z < \text{SSR withstand voltage}$$

$$- (\text{Power supply voltage} + 2 V)$$

$$\text{Zener surge power} =$$

$$P_{RSM} > V_z \times \text{Load current} \times \text{Safety factor (2 to 3)}$$

Note. When the Zener voltage is increased ( $V_z$ ), the Zener diode capacity ( $P_{RSM}$ ) is also increased.

### AND Circuits with DC Output SSRs

Use the G3DZ relay for the following type of circuit.

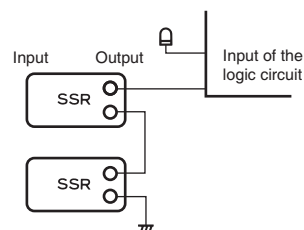

### Self-holding Circuits

Self-holding circuits must use mechanical relays. (SSRs cannot be used to design self-holding circuits.)



# Solid State Relays Common Precautions

## ●Selecting an SSR for Different Loads

The following provides examples of the inrush currents for different loads.

### AC Load and Inrush Current

| Load                          | Solenoid         | Incandescent lamp      | Motor                 | Relay                | Capacitor              | Resistive load |
|-------------------------------|------------------|------------------------|-----------------------|----------------------|------------------------|----------------|
| Inrush current/Normal current | Approx. 10 times | Approx. 10 to 15 times | Approx. 5 to 10 times | Approx. 2 to 3 times | Approx. 20 to 50 times | 1              |
| Waveform                      |                  |                        |                       |                      |                        |                |

### 1. Heater Load (Resistive Load)

A resistive load has no inrush current. The SSR is generally used together with a pulse-voltage-output in temperature controller for heater ON/OFF switching. When using an SSR with the zero cross function, most generated noise is suppressed. This type of load does not, however, include all-metal and ceramic heaters. Since the resistance values at normal temperatures of all-metal and ceramic heaters are low, an overcurrent will occur in the SSR, causing damage. For switching of all-metal and ceramic heaters, select a Power Controller (G3PW, consult your OMRON representative) with a long soft-start time, or a constant-current switch.

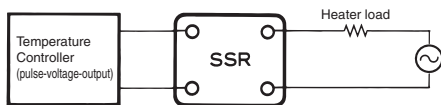

### 2. Lamp Load

A large inrush current flows through incandescent lamps, halogen lamps, and similar devices (approx. 10 to 15 times higher than the rated current). Select an SSR so that the peak value of inrush current does not exceed half the inrush current resistance of the SSR. Refer to "Repetitive" (indicated by the dashed line) shown in the following figure. When a repetitive inrush current of greater than half the inrush current resistance is applied, the output element of the SSR may be damaged.

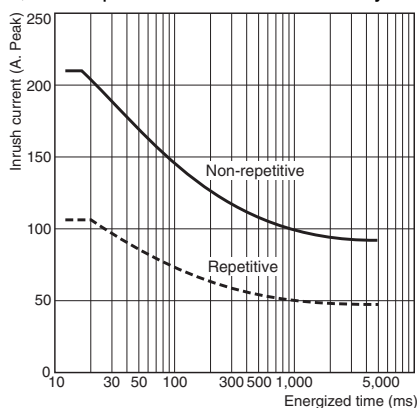

### 3. Motor Load

When a motor is started, an inrush current of 5 to 10 times the rated current flows and the inrush current flows for a longer time than for a lamp or transformer. In addition to measuring the startup time of the motor or the inrush current during use, ensure that the peak value of the inrush current is less than half the inrush current resistance when selecting an SSR. The SSR may be damaged by counterelectromotive force from the motor. Be sure to install overcurrent protection for when the SSR is turned OFF.

### 4. Transformer Load

When the SSR is switched ON, an energizing current of 10 to 20 times the rated current flows through the SSR for 10 to 500 ms. If there is no load in load side circuit, the energizing current will reach the maximum value. Select an SSR so that the energizing current does not exceed half the inrush current resistance of the SSR.

### 5. Half-wave Rectifying Circuit

AC electromagnetic counters or solenoids have built-in diodes, which act as half-wave rectifiers. For these types of loads, a halfwave AC voltage does not reach the SSR output. For SSRs with the zero cross function, this can cause them not to turn ON. Two methods for counteracting this problem are described below.

1. Connect a bleeder resistance with approximately 20% of the SSR load current.

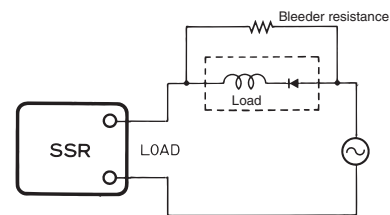

2. Use SSRs without the zero cross function.

### 6. Full-wave Rectified Loads

AC electromagnetic counters and solenoids have built-in diodes, which act as full-wave rectifiers. The load current for these types of loads has a rectangular wave pattern, as shown in the following diagram.

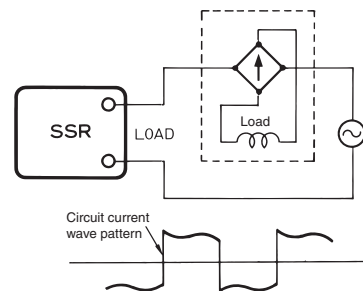

Accordingly, AC SSRs use a triac (which turns OFF the element only when the circuit current is 0 A) in the output element. If the load current waveform is rectangular, it will result in an SSR release error.

When switching ON and OFF a load whose waves are all rectified, use Power MOS FET Relay.

-V-model SSRs: G3F-203SL-V, G3H-203SL-V

Power MOS FET Relay: G3DZ, G3RZ, G3FM

Note. Refer to your OMRON website for detailed specification of G3FM models.

### 7. Small-capacity Loads

Even when there is no input signal to the SSR, there is a small leakage current (IL) from the SSR output (LOAD). If this leakage current is larger than the load release current, the SSR may fail to release. Connect a bleeder resistance R in parallel to increase the SSR switching current.

$$R < \frac{E}{I_L - I}$$

E: Load (e.g., relays) release voltage  
I: Load (e.g., relays) release current

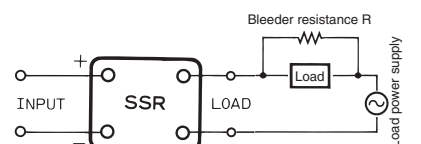

Bleeder resistance standards: 100-VAC power supply, 5 to 10 kΩ, 3 W  
200-VAC power supply, 5 to 10 kΩ, 15 W

# Solid State Relays Common Precautions

## 8. Inverter Load

Do not use an inverter-controlled power supply as the load power supply for the SSR. Inverter-controlled waveforms become rectangular, so the  $dV/dt$  ratio is extremely large and the SSR may fail to release.

An inverter-controlled power supply may be used on the input side provided the effective voltage is within the normal operating voltage range of the SSR.

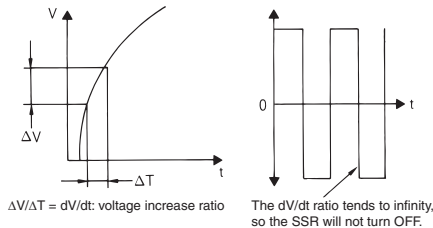

## 9. Capacitive Load

The supply voltage plus the charge voltage of the capacitor is applied to both ends of the SSR when it is OFF. Therefore, use an SSR model with an input voltage rating twice the size of the supply voltage. Limit the charge current of the capacitor to less than half the peak inrush current value allowed for the SSR.

## 10. SSR for DC Switching

### Connection

With the SSR for DC switching, the load can be connected to either negative (-) or positive (+) output terminal of the SSR.

### Protective Component

Since the SSR does not incorporate an overvoltage absorption component, be sure to connect an overvoltage absorption component when using the SSR under an inductive load.

## Load Power Supply

### 1. Rectified Currents

If a DC load power supply is used for full-wave or half-wave rectified AC currents, make sure that the peak load current does not exceed the maximum usage load power supply of the SSR. Otherwise, overvoltage will cause damage to the output element of the SSR.

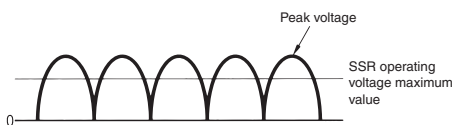

### 2. Operating Frequency for AC Load Power Supply

The operating frequency range for an AC load power supply is 47 to 63 Hz.

### 3. Low AC Voltage Loads

If the load power supply is used under a voltage below the minimum operating load voltage of the SSR, the loss time of the voltage applied to the load will become longer than that of the SSR operating voltage range. See the following load example. (The loss time is  $A < B$ .)

Before operating the SSR, make sure that this loss time will not cause problems.

If the load voltage falls below the trigger voltage, the SSR will not turn ON, so be sure to set the load voltage to 75 VAC min.

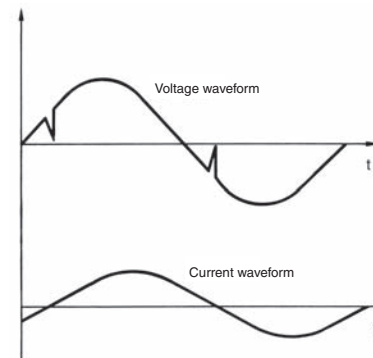
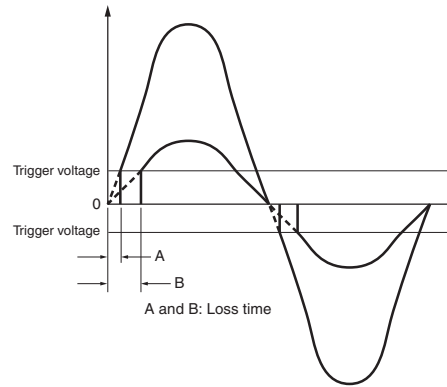

## 4. Phase-controlled AC Power Supplies

Phase-controlled power supply cannot be used.

## Operating and Storage Environments

### 1. Operating Ambient Temperature

The rated value for the ambient operating temperature of the SSR is for when there is no heat build-up. For this reason, under conditions where heat dissipation is not good due to poor ventilation, and where heat may build up easily, the actual temperature of the SSR may exceed the rated value resulting in malfunction or burning.

When using the SSR, design the system to allow heat dissipation sufficient to stay below the "●Load Current vs. Ambient Temperature" characteristic curve. Note also that the ambient temperature of the SSR may increase as a result of environmental conditions (e.g., climate or air-conditioning) and operating conditions (e.g., mounting in an airtight panel).

### 2. Transportation

When transporting the SSR, observe the following points. Not doing so may result in damage, multifunction, or deterioration of performance characteristics.

### 3. Vibration and Shock

Do not subject the SSR to excessive vibration or shock. Otherwise the SSR may malfunction and internal components may be damaged.

To prevent the SSR from abnormal vibration, do not install the SSR in locations or by means that will subject it to vibration from other devices, such as motors.

### 4. Solvents

Do not allow the SSR to come in contact with solvents, such as thinners or gasoline. Doing so will dissolve the markings on the SSR.

### 5. Oil

Do not allow the SSR terminal cover to come in contact with oil. Doing so will cause the cover to crack and become cloudy.

# Solid State Relays Common Precautions

## Actual Operation

### 1. Leakage Current

A leakage current flows through a snubber circuit in the SSR even when there is no input. Therefore, always turn OFF the input or load and check that it is safe before replacing or wiring the SSR.

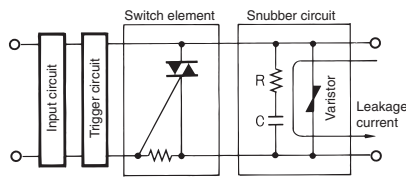

### 2. Cutting Terminals

Do not cut the terminals using an automated-cutter. Cutting the terminals with devices such as an automated-cutter may damage the internal components.

### 3. Deformed Terminals

Do not attempt to repair or use a terminal that has been deformed. Otherwise excessive force will be applied to the SSR, and it will lose its original performance capabilities.

### 4. Hold-down Clips

Exercise care when pulling or inserting the hold-down clips so that their form is not distorted. Do not use a clip that has already been deformed. Otherwise excessive force will be applied to the SSR, causing it not to perform to its specification, and also it will not have enough holding power, causing the SSR to be loose, and resulting in damage to the contacts.

### 5. PCB SSR Soldering

- SSRs must be soldered at 260°C within five seconds. For models, however, that conform to separate conditions, perform soldering according to the specified requirements.
- Use a rosin-based non-corrosive flux that is compatible with the material of the SSR.

### 6. Ultrasonic Cleaning

Do not perform ultrasonic cleaning. Performing ultrasonic cleaning after the SSR base has been installed will cause ultrasonic waves to resonate throughout the SSR internal structure, thereby damaging the internal components.

## Safety Concept

### 1. Error Mode

The SSR is an optimum relay for high-frequency switching and highspeed switching, but misuse or mishandling of the SSR may damage the elements and cause other problems. The SSR consists of semiconductor elements, and will break down if these elements are damaged by surge voltage or overcurrent. Most faults associated with the elements are short-circuit malfunctions, whereby the load cannot be turned OFF. Therefore, to provide a safety feature for a control circuit using an SSR, design a circuit in which a contactor or circuit breaker on the load power supply side will turn OFF the load when the SSR causes an error. Do not design a circuit that turns OFF the load power supply only with the SSR. For example, if the SSR causes a half-wave error in a circuit in which an AC motor is connected as a load, DC energizing may cause overcurrent to flow through the motor, thus burning the motor. To prevent this from occurring, design a circuit in which a circuit breaker stops overcurrent to the motor.

| Location    | Cause                                 | Result                |
|-------------|---------------------------------------|-----------------------|
| Input area  | Overvoltage                           | Input element damage  |
| Output area | Overvoltage                           | Output element damage |
|             | Overcurrent                           |                       |
| Whole Unit  | Ambient temperature exceeding maximum | Output element damage |
|             | Poor heat radiation                   |                       |

### 2. Short-circuit Protection

A short-circuit current or an overcurrent flowing through the load of the SSR will damage the output element of the SSR. Connect a quick-break fuse in series with the load as a short-circuit protection measure.

Design a circuit so that the protection coordination conditions for the quick-break fuse satisfy the relationship between the SSR surge resistance ( $I_s$ ), quick-break fuse current-limiting feature ( $I_f$ ), and the load inrush current ( $I_L$ ), shown in the following chart.

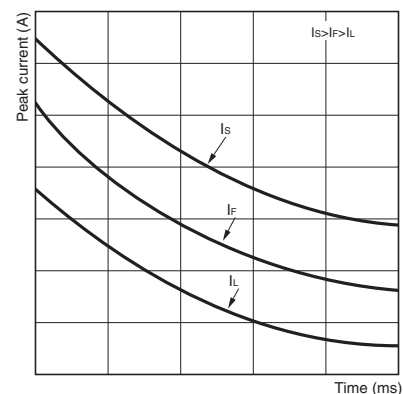

### 3. Operation Indicator

The operation indicator turns ON when current flows through the input circuit. It does not indicate that the output element is ON.

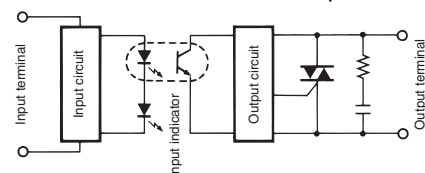

# Solid State Relays Common Precautions

## ■HANDLING THE SSR

### ●Do Not Drop

The SSR is a high-precision component. Do not drop the SSR or subject it to excessive vibration or shock regardless of whether the SSR is mounted or not.

The maximum vibration and shock that an SSR can withstand varies with the model. Refer to the relevant datasheet.

The SSR cannot maintain its full performance capability if the SSR is dropped or subjected to excessive vibration or shock. In addition, it may result in malfunction due to its damaged internal components if the SSR is dropped or subjected to excessive vibration or shock.

The impact of shock given to the SSR that is dropped varies upon the case. For example, if a single SSR is dropped on a plastic tile from a height of 10 cm, the SSR may receive a shock of 1,000 m/s<sup>2</sup> or more. (It depends on the floor material, the angle of collision with the floor, and the dropping height.)

Handle the SSR models in stick packages with the same care and keep them free from excessive vibration or shock.

### ●Terminal arrangement/Internal connections

#### 1. BOTTOM VIEW

If the relay's terminals cannot be seen from above, as in this example, a BOTTOM VIEW is shown.

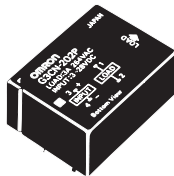

#### 2. Rotating direction to BOTTOM VIEW

The following shows the terminal rotated in the direction indicated by the arrow, with the coil always on the left (orientation mark on the left).

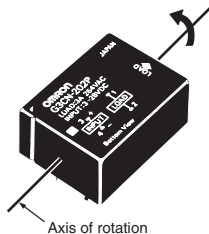

## ■PCB-mounting SSRs

### 1. Suitable PCBs

#### 1 PCB Material

PCBs are classified into epoxy PCBs and phenol PCBs. The following table lists the characteristics of these PCBs. Select one, taking into account the application and cost. Epoxy PCBs are recommended for SSR mounting in order to prevent the solder from cracking.

| Item                       | Epoxy   |  | Phenol  |
|----------------------------|---|--|---|
|                            | Glass epoxy (GE)  | Paper epoxy (PE)   | Paper phenol (PP)   |
| Electrical characteristics | <ul style="list-style-type: none"> <li>High insulation resistance.</li> <li>Highly resistive to moisture absorption.</li> </ul>   | <ul style="list-style-type: none"> <li>Inferior to glass epoxy but superior to paper phenol PCBs.</li> </ul>   | <ul style="list-style-type: none"> <li>New PCBs are highly insulation-resistant but easily affected by moisture absorption and cannot maintain good insulation performance over a long time.</li> </ul> |
| Mechanical characteristics | <ul style="list-style-type: none"> <li>The dimensions are not easily affected by temperature or humidity.</li> <li>Ideal for through-hole or multi-layer PCBs.</li> </ul> | <ul style="list-style-type: none"> <li>Inferior to glass epoxy but superior to paper phenol PCBs.</li> </ul>   | <ul style="list-style-type: none"> <li>The dimensions are easily affected by temperature or humidity.</li> <li>Not suitable for through-hole PCBs.</li> </ul>   |
| Economical efficiency      | <ul style="list-style-type: none"> <li>Expensive</li> </ul>   | <ul style="list-style-type: none"> <li>Rather expensive</li> </ul>   | <ul style="list-style-type: none"> <li>Inexpensive</li> </ul>   |
| Application                | <ul style="list-style-type: none"> <li>Applications that require high reliability.</li> </ul>   | <ul style="list-style-type: none"> <li>Applications that may require less reliability than those for glass epoxy PCBs but require more reliability than those of paper phenol PCBs.</li> </ul> | <ul style="list-style-type: none"> <li>Applications in comparatively good environments with low-density wiring.</li> </ul>  |

#### 2 PCB Thickness

The PCB may warp due to the size, mounting method, or ambient operating temperature of the PCB or the weight of components mounted to the PCB. Should warping occur, the internal mechanism of the SSR on the PCB will be deformed and the SSR may not provide its full capability. Determine the thickness of the PCB by taking the material of the PCB into consideration.

#### 3 Terminal Hole and Land Diameters

Refer to the following table to select the terminal hole and land diameters based on the SSR mounting dimensions. The land diameter may be smaller if the land is processed with through-hole plating.

| Hole dia. (mm) |           | Minimum land dia. (mm) |
|----------------|-----------|------------------------|
| Nominal value  | Tolerance |                        |
| 0.6            | ±0.1      | 1.5                    |
| 0.8            |           | 1.8                    |
| 1.0            |           | 2.0                    |
| 1.2            |           | 2.5                    |
| 1.3            |           | 2.5                    |
| 1.5            |           | 3.0                    |
| 1.6            |           | 3.0                    |
| 2.0            |           | 3.0                    |

#### 2. Mounting Space

The ambient temperature around the sections where the SSR is mounted must be within the permissible ambient operating temperature. If two or more SSRs are mounted closely together, the SSRs may radiate excessive heat. Therefore, make sure that the SSRs are separated from one another at the specified distance provided in the datasheet. If there is no such specification, maintain a space that is as wide as a single SSR. Provide adequate ventilation to the SSRs as shown in the following diagram.

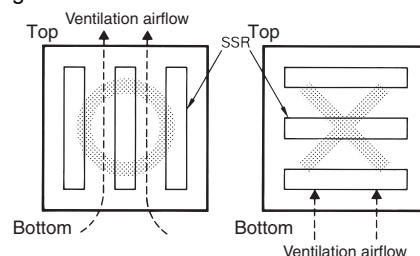

# Solid State Relays Common Precautions

## 3. Mounting SSR to PCB

Read the precautions for each model and fully familiarize yourself with the following information when mounting the SSR to the PCB.



**Step 1**  
**SSR mounting**

1. Do not bend the terminals to make the SSR self-standing, otherwise the full performance of the SSR may not be possible.
2. Process the PCB properly according to the mounting dimensions.

**Step 2**  
**Flux coating**

1. The flux must be a non-corrosive rosin flux, which is suitable to the material of the SSR. Apply alcohol solvent to dissolve the flux.
2. Make sure that all parts of the SSR other than the terminals are free of the flux. The insulation resistance of the SSR may be degraded if there is flux on the bottom of the SSR.

**Step 3**  
**Preheating**

1. Be sure to preheat the SSR to allow better soldering.
2. Preheat the SSR under the following conditions.

|                    |            |
|--------------------|------------|
| <b>Temperature</b> | 100°C max. |
| <b>Time</b>        | 1 min max. |

3. Do not use the SSR if it is left at high temperature over a long time. This may change the characteristics of the SSR.

**Step 4**  
**Soldering**

### ●Automatic Soldering

1. Flow soldering is recommended for maintaining a uniform soldering quality.
  - Solder: JIS Z3282 or H63A
  - Soldering temperature: Approx. 250°C (Approx. 260°C for DWS)
  - Soldering time: Approx. 5 s (Approx. 2 s for first time and approx. 3 s for second time for DWS)
  - Perform solder level adjustments so that the solder will not overflow on the PCB.

### ●Manual Soldering

1. After smoothing the tip of the soldering iron, solder the SSR under the following conditions.
  - Solder: JIS Z3282, 1160A, or H63A with rosin-flux-cored solder
  - Soldering iron: 30 to 80 W
  - Soldering temperature: 280°C to 350°C
  - Soldering time: Approx. 3 s
2. As shown in the above illustration, solder with a groove for preventing flux dispersion.

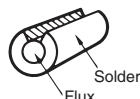

**Step 5**  
**Cooling**

1. After soldering the SSR, be sure to cool down the SSR so that the soldering heat will not deteriorate the SSR or any other components.
2. Do not dip the SSR into cold liquid, such as a detergent, immediately after soldering the SSR.

**Step 6**  
**Cleaning**

1. Refer to the following table for the selection of the cleaning method and detergent.

### Detergent

Boiling or dip cleaning is possible for the SSR. Do not perform ultrasonic cleaning or cut the terminals, otherwise the internal parts of the SSR may be damaged. Make sure that the temperature of the detergent is within the permissible ambient operating temperature of the SSR.

2. Applicability of Detergents

| Detergent          |   | Applicability |
|--------------------|---|---------------|
| Chlorine detergent | <ul style="list-style-type: none"> <li>• Perochline</li> <li>• Chlorosolder</li> <li>• Trichloroethylene</li> </ul> | OK            |
| Aqueous detergent  | <ul style="list-style-type: none"> <li>• Indusco</li> <li>• Pure water (pure hot water)</li> <li>• Holys</li> </ul> | OK            |
| Alcohol            | <ul style="list-style-type: none"> <li>• IPA</li> <li>• Ethanol</li> </ul>  | OK            |
| Others             | <ul style="list-style-type: none"> <li>• Paint thinner</li> <li>• Gasoline</li> </ul>                               | NG            |

Note 1. Contact your OMRON representatives before using any other detergent. Do not apply Freon TMC, paint thinner, or gasoline to any SSR.

Note 2. The space between the SSR and PCB may not be adequately cleaned with a hydrocarbon or alcohol detergent.

Actions are being taken worldwide to stop the use of CFC-113 (chlorofluorocarbon) and 1.1.1 trichloroethane. Your understanding and cooperation are highly appreciated.

**Step 7**  
**Coating**

1. Do not fix the whole SSR with resin, otherwise the characteristics of the SSR may change.
2. The temperature of the coating material must be within the permissible ambient operating temperature range.

### Coating

| Type     | Applicability |
|----------|---------------|
| Epoxy    | OK            |
| Urethane | OK            |
| Silicone | OK            |

Note. When soldering PCB SSR with high-heat capacity such as the G3M, make sure that the soldering of SSR terminals is properly performed.

# Solid State Relays Common Precautions

## ■ Application Circuit Examples

### 1. Connection to Sensors

The SSR connects directly to a Proximity Sensor or Photoelectric Sensor.

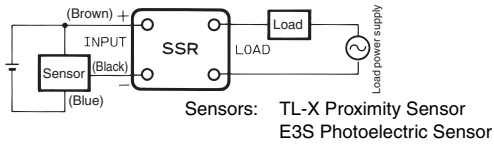

### 2. Switching Control of Incandescent Lamps

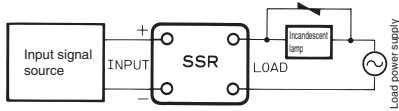

### 3. Temperature Control of Electric Furnaces

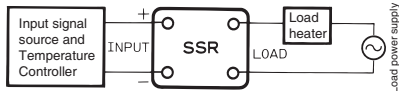

### 4. Forward and Reverse Operation of Singlephase Inductive Motors

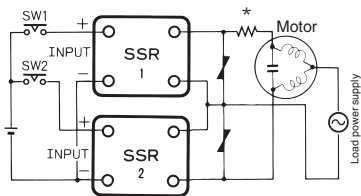

Note 1. The voltage between the load terminals of either SSR 1 or SSR 2 when turned OFF is approximately twice as high as the supply voltage due to LC coupling. Be sure to use an SSR model with a rated output voltage of at least twice the supply voltage. For example, if the motor operates at a supply voltage of 100 VAC, the SSR must have an output voltage of 200 VAC or higher.

Note 2. Make sure that there is a time lag of 30 ms or more to switch over SW1 and SW2.

\* Resistor to limit advanced phase capacitor discharge current. To select a suitable resistor, consult with the manufacturer of the motor.

# Terms and Conditions of Sale

1. **Offer; Acceptance.** These terms and conditions (these "**Terms**") are deemed part of all quotes, agreements, purchase orders, acknowledgments, price lists, catalogs, manuals, brochures and other documents, whether electronic or in writing, relating to the sale of products or services (collectively, the "**Products**") by Omron Electronics LLC and its subsidiary companies ("**Omron**"). Omron objects to any terms or conditions proposed in Buyer's purchase order or other documents which are inconsistent with, or in addition to, these Terms.
2. **Prices; Payment Terms.** All prices stated are current, subject to change without notice by Omron. Omron reserves the right to increase or decrease prices on any unshipped portions of outstanding orders. Payments for Products are due net 30 days unless otherwise stated in the invoice.
3. **Discounts.** Cash discounts, if any, will apply only on the net amount of invoices sent to Buyer after deducting transportation charges, taxes and duties, and will be allowed only if (i) the invoice is paid according to Omron's payment terms and (ii) Buyer has no past due amounts.
4. **Interest.** Omron, at its option, may charge Buyer 1-1/2% interest per month or the maximum legal rate, whichever is less, on any balance not paid within the stated terms.
5. **Orders.** Omron will accept no order less than \$200 net billing.
6. **Governmental Approvals.** Buyer shall be responsible for, and shall bear all costs involved in, obtaining any government approvals required for the importation or sale of the Products.
7. **Taxes.** All taxes, duties and other governmental charges (other than general real property and income taxes), including any interest or penalties thereon, imposed directly or indirectly on Omron or required to be collected directly or indirectly by Omron for the manufacture, production, sale, delivery, importation, consumption or use of the Products sold hereunder (including customs duties and sales, excise, use, turnover and license taxes) shall be charged to and remitted by Buyer to Omron.
8. **Financial.** If the financial position of Buyer at any time becomes unsatisfactory to Omron, Omron reserves the right to stop shipments or require satisfactory security or payment in advance. If Buyer fails to make payment or otherwise comply with these Terms or any related agreement, Omron may (without liability and in addition to other remedies) cancel any unshipped portion of Products sold hereunder and stop any Products in transit until Buyer pays all amounts, including amounts payable hereunder, whether or not then due, which are owing to it by Buyer. Buyer shall in any event remain liable for all unpaid accounts.
9. **Cancellation; Etc.** Orders are not subject to rescheduling or cancellation unless Buyer indemnifies Omron against all related costs or expenses.
10. **Force Majeure.** Omron shall not be liable for any delay or failure in delivery resulting from causes beyond its control, including earthquakes, fires, floods, strikes or other labor disputes, shortage of labor or materials, accidents to machinery, acts of sabotage, riots, delay in or lack of transportation or the requirements of any government authority.
11. **Shipping; Delivery.** Unless otherwise expressly agreed in writing by Omron:
  - a. Shipments shall be by a carrier selected by Omron; Omron will not drop ship except in "break down" situations.
  - b. Such carrier shall act as the agent of Buyer and delivery to such carrier shall constitute delivery to Buyer;
  - c. All sales and shipments of Products shall be FOB shipping point (unless otherwise stated in writing by Omron), at which point title and risk of loss shall pass from Omron to Buyer; provided that Omron shall retain a security interest in the Products until the full purchase price is paid;
  - d. Delivery and shipping dates are estimates only; and
  - e. Omron will package Products as it deems proper for protection against normal handling and extra charges apply to special conditions.
12. **Claims.** Any claim by Buyer against Omron for shortage or damage to the Products occurring before delivery to the carrier must be presented in writing to Omron within 30 days of receipt of shipment and include the original transportation bill signed by the carrier noting that the carrier received the Products from Omron in the condition claimed.
13. **Warranties.** (a) **Exclusive Warranty.** Omron's exclusive warranty is that the Products will be free from defects in materials and workmanship for a period of twelve months from the date of sale by Omron (or such other period expressed in writing by Omron). Omron disclaims all other warranties, express or implied. (b) **Limitations.** OMRON MAKES NO WARRANTY OR REPRESENTATION, EXPRESS OR IMPLIED, ABOUT NON-INFRINGEMENT, MERCHANTABILITY OR FITNESS FOR A PARTICULAR PURPOSE OF THE PRODUCTS. BUYER ACKNOWLEDGES THAT IT ALONE HAS DETERMINED THAT THE PRODUCTS WILL SUITABLY MEET THE REQUIREMENTS OF THEIR INTENDED USE. Omron further disclaims all warranties and responsibility of any type for claims or expenses based on infringement by the Products or otherwise of any intellectual property right. (c) **Buyer Remedy.** Omron's sole obligation hereunder shall be, at Omron's election, to (i) replace (in the form originally shipped with Buyer responsible for labor charges for removal or replacement thereof) the non-complying Product, (ii) repair the non-complying Product, or (iii) repay or credit Buyer an amount equal to the purchase price of the non-complying Product; provided that in no event shall Omron be responsible for warranty, repair, indemnity or any other claims or expenses regarding the Products unless Omron's analysis confirms that the Products were properly handled, stored, installed and maintained and not subject to contamination, abuse, misuse or inappropriate modification. Return of any Products by Buyer must be approved in writing by Omron before shipment. Omron Companies shall not be liable for the suitability or unsuitability or the results from the use of Products in combination with any electrical or electronic components, circuits, system assemblies or any other materials or substances or environments. Any advice, recommendations or information given orally or in writing, are not to be construed as an amendment or addition to the above warranty. See <http://www.omron247.com> or contact your Omron representative for published information.
14. **Limitation on Liability; Etc.** OMRON COMPANIES SHALL NOT BE LIABLE FOR SPECIAL, INDIRECT, INCIDENTAL, OR CONSEQUENTIAL DAMAGES, LOSS OF PROFITS OR PRODUCTION OR COMMERCIAL LOSS IN ANY WAY CONNECTED WITH THE PRODUCTS, WHETHER SUCH CLAIM IS BASED IN CONTRACT, WARRANTY, NEGLIGENCE OR STRICT LIABILITY. Further, in no event shall liability of Omron Companies exceed the individual price of the Product on which liability is asserted.
15. **Indemnities.** Buyer shall indemnify and hold harmless Omron Companies and their employees from and against all liabilities, losses, claims, costs and expenses (including attorney's fees and expenses) related to any claim, investigation, litigation or proceeding (whether or not Omron is a party) which arises or is alleged to arise from Buyer's acts or omissions under these Terms or in any way with respect to the Products. Without limiting the foregoing, Buyer (at its own expense) shall indemnify and hold harmless Omron and defend or settle any action brought against such Companies to the extent based on a claim that any Product made to Buyer specifications infringed intellectual property rights of another party.
16. **Property; Confidentiality.** Any intellectual property in the Products is the exclusive property of Omron Companies and Buyer shall not attempt to duplicate it in any way without the written permission of Omron. Notwithstanding any charges to Buyer for engineering or tooling, all engineering and tooling shall remain the exclusive property of Omron. All information and materials supplied by Omron to Buyer relating to the Products are confidential and proprietary, and Buyer shall limit distribution thereof to its trusted employees and strictly prevent disclosure to any third party.
17. **Export Controls.** Buyer shall comply with all applicable laws, regulations and licenses regarding (i) export of products or information; (ii) sale of products to "forbidden" or other proscribed persons; and (iii) disclosure to non-citizens of regulated technology or information.
18. **Miscellaneous.** (a) **Waiver.** No failure or delay by Omron in exercising any right and no course of dealing between Buyer and Omron shall operate as a waiver of rights by Omron. (b) **Assignment.** Buyer may not assign its rights hereunder without Omron's written consent. (c) **Law.** These Terms are governed by the law of the jurisdiction of the home office of the Omron company from which Buyer is purchasing the Products (without regard to conflict of law principles). (d) **Amendment.** These Terms constitute the entire agreement between Buyer and Omron relating to the Products, and no provision may be changed or waived unless in writing signed by the parties. (e) **Severability.** If any provision hereof is rendered ineffective or invalid, such provision shall not invalidate any other provision. (f) **Setoff.** Buyer shall have no right to set off any amounts against the amount owing in respect of this invoice. (g) **Definitions.** As used herein, "including" means "including without limitation"; and "Omron Companies" (or similar words) mean Omron Corporation and any direct or indirect subsidiary or affiliate thereof.

## Certain Precautions on Specifications and Use

1. **Suitability of Use.** Omron Companies shall not be responsible for conformity with any standards, codes or regulations which apply to the combination of the Product in the Buyer's application or use of the Product. At Buyer's request, Omron will provide applicable third party certification documents identifying ratings and limitations of use which apply to the Product. This information by itself is not sufficient for a complete determination of the suitability of the Product in combination with the end product, machine, system, or other application or use. Buyer shall be solely responsible for determining appropriateness of the particular Product with respect to Buyer's application, product or system. Buyer shall take application responsibility in all cases but the following is a non-exhaustive list of applications for which particular attention must be given: (i) Outdoor use, uses involving potential chemical contamination or electrical interference, or conditions or uses not described in this document. (ii) Use in consumer products or any use in significant quantities. (iii) Energy control systems, combustion systems, railroad systems, aviation systems, medical equipment, amusement machines, vehicles, safety equipment, and installations subject to separate industry or government regulations. (iv) Systems, machines and equipment that could present a risk to life or property. Please know and observe all prohibitions of use applicable to this Product. NEVER USE THE PRODUCT FOR AN APPLICATION INVOLVING SERIOUS RISK TO LIFE OR PROPERTY OR IN LARGE QUANTITIES WITHOUT ENSURING THAT THE SYSTEM AS A WHOLE HAS BEEN DESIGNED TO ADDRESS THE RISKS, AND THAT THE OMRON'S PRODUCT IS PROPERLY RATED AND INSTALLED FOR THE INTENDED USE WITHIN THE OVERALL EQUIPMENT OR SYSTEM.
2. **Programmable Products.** Omron Companies shall not be responsible for the user's programming of a programmable Product, or any consequence thereof.
3. **Performance Data.** Data presented in Omron Company websites, catalogs and other materials is provided as a guide for the user in determining suitability and does not constitute a warranty. It may represent the result of Omron's test conditions, and the user must correlate it to actual application requirements. Actual performance is subject to the Omron's Warranty and Limitations of Liability.
4. **Change in Specifications.** Product specifications and accessories may be changed at any time based on improvements and other reasons. It is our practice to change part numbers when published ratings or features are changed, or when significant construction changes are made. However, some specifications of the Product may be changed without any notice. When in doubt, special part numbers may be assigned to fix or establish key specifications for your application. Please consult with your Omron's representative at any time to confirm actual specifications of purchased Product.
5. **Errors and Omissions.** Information presented by Omron Companies has been checked and is believed to be accurate; however, no responsibility is assumed for clerical, typographical or proofreading errors or omissions.